

**RS**





# Tourea

## Rigging Manual

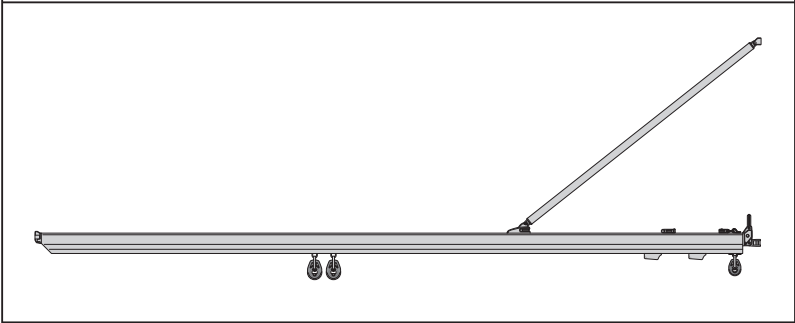
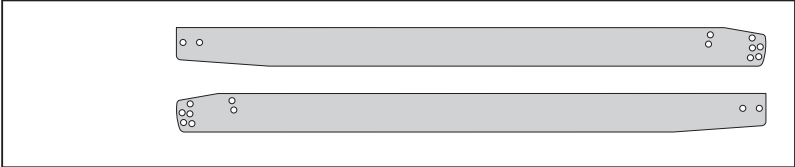
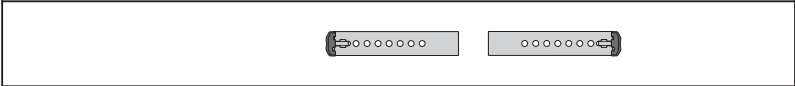
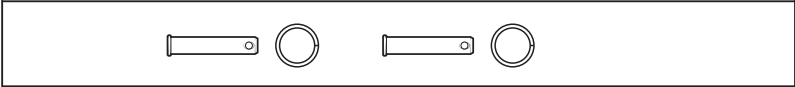
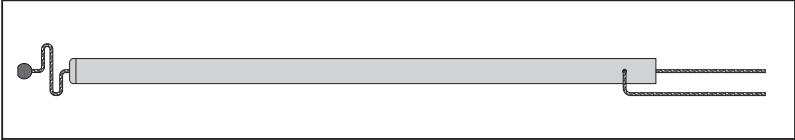
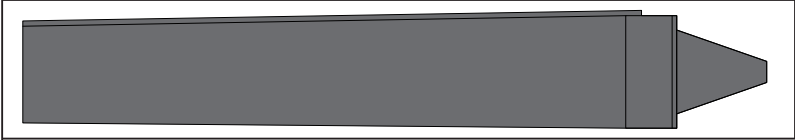
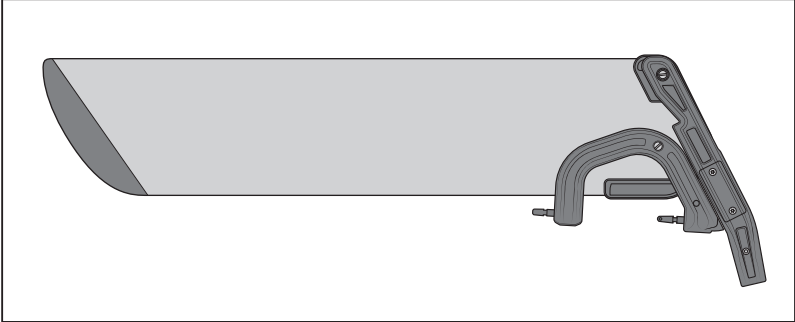

# Contents

<b>1. Components .....</b>	<b>1</b>
1.1 - Spars .....	1
1.2 - Rudder pack .....	1
1.3 - Customer pack .....	2
1.4 - Rope pack .....	3
1.5 - Asymmetrical spinnaker pack .....	4
1.7 - Asymmetrical spinnaker rope pack .....	5
<b>2. Introduction .....</b>	<b>6</b>
<b>3. Preparation .....</b>	<b>7</b>
<b>4. Hull .....</b>	<b>8</b>
4.1 - Toestraps .....	9
4.2 - Shroud eye bolts .....	10
4.3 - Asymmetrical spinnaker fittings .....	11
4.5 - Adding the spinnaker sock .....	16
<b>5. Mast .....</b>	<b>18</b>
5.2 - Fitting the spreaders to the mast .....	19
5.3 - Attaching the shrouds .....	20
5.4 - Spreader ends .....	20
5.5 - Main halyard .....	21
5.6 - Jib halyard .....	21
5.7 - Forestay .....	22
5.8 - Spinnaker halyard takeup elastic .....	22
5.9 - Spinnaker halyard mast turning blocks .....	23
5.10 - Masthead float .....	24
5.11 - Shrouds .....	25
5.12 - Stepping the mast .....	27
5.13 - Forestay .....	28
<b>6. Boom .....</b>	<b>29</b>
6.1 - Fitting the boom .....	30
6.2 - Gnav control line .....	31
6.3 - Mainsheet .....	32
<b>7. Sails - Mainsail and Jib .....</b>	<b>34</b>
7.1 - Preparing the sails .....	35
7.2 - Battens .....	36
7.3 - Sail care .....	36
7.4 - Hoisting the jib .....	37
7.5 - Outhaul .....	41
7.6 - Hoisting the mainsail .....	42
7.7 - Downhaul .....	44
<b>8. Spinnaker .....</b>	<b>45</b>
8.1 - Rigging the asymmetric spinnaker .....	46
<b>9. Foils .....</b>	<b>49</b>
9.1 - Rudder .....	50
9.2 - Centreboard .....	52
<b>10. Reefing .....</b>	<b>53</b>
10.1 - Rigging the reefing line .....	54
10.2 - Reefing the mainsail .....	54
<b>11. Trapeze Kit .....</b>	<b>56</b>
<b>12. Outboard bracket .....</b>	<b>60</b>
<b>13. Sailing Hints .....</b>	<b>63</b>

<i>RS</i> Toura 1.1 - Spars		Quantity	Description
		1	Mast
		1	Boom
		2	Spreaders
		2	Spreader Ends
		2	Clevis Pin & Split Ring
		(OPTIONAL) 1	Bowsprit
		(OPTIONAL) 1	Spinnaker Sock
<hr/>			
<i>RS</i> Toura 1.2 - Rudder Pack		Quantity	Description
		1	Rudder Assembly
		1	Tiller
		1	Tiller Extension
		2	Screws
<hr/>			

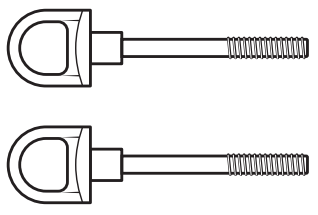

2

Shroud eye bolts

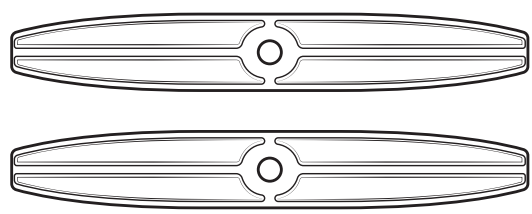

2

Shroud recess bars



1

Plastic bobble  
(Main halyard)

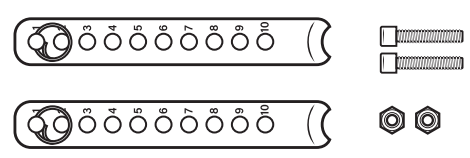

2

Shroud adjuster plates  
with nut and bolts

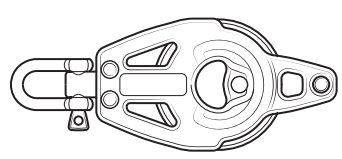

1

40mm block with  
becket (mainsheet)

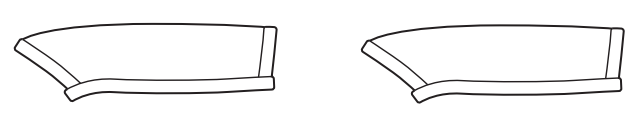

2

Shroud VernierCovers

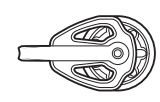

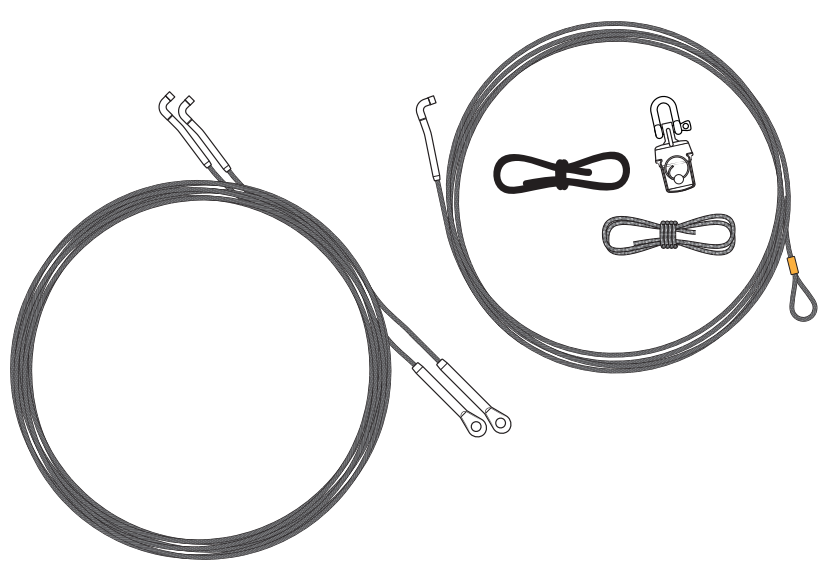

1

20mm block  
(Downhaul)

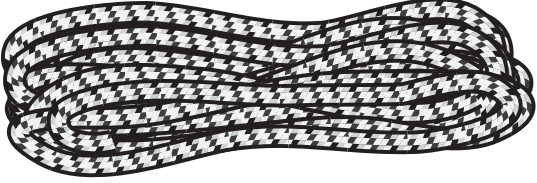
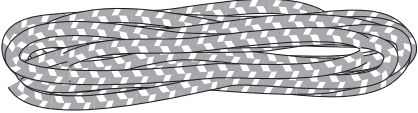
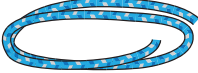
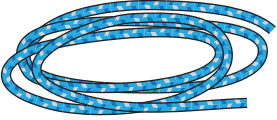

1

Rig Pack

1.4 - Customer Rope Pack	Quantity	Description
	1	Mainsheet
	1	Jib Sheet
	1	Downhaul 1
	1	Downhaul 2
	1	Mainsheet Strop
	1	Main Halyard

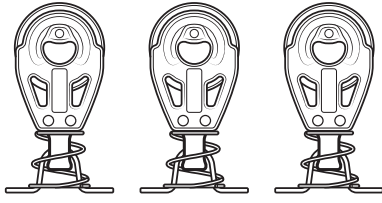

3

Block, BBB30 Single, Stand-Up



1

Ring Ø28/20/Ø4mm ST

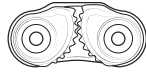

1

Camcleat 27



1

Lineguide 27



1

2-P Eye



1

Block, BBB30 Single, Swivel

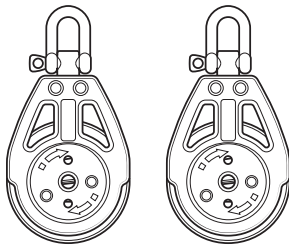

2

Block, ARB45 Single



1

Stopper Knob 6mm



3

Screw Pozi Pan M4 X 25

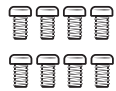

8

M/Screw, M5 X 8, Pozi Pan



1

Screw Pozi Pan M4 X 12



1

Block, BBB30 Cheek



1

Block, BBB30 Single, Strap



1

Spinnaker Sock Tie



1

Halyard Take Up

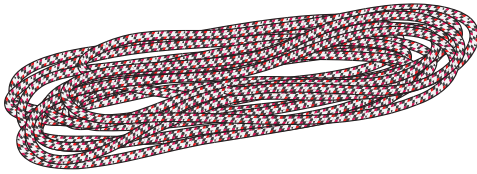

1

Spinnaker Halyard

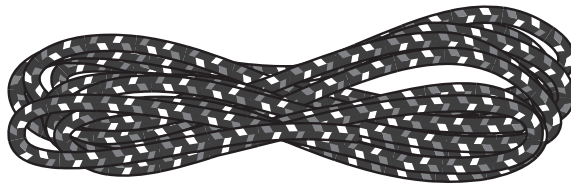

1

Spinnaker Sheet

## 2 - Introduction

Congratulations on the purchase of your new RS Toura, and thank you for choosing an RS product. We are confident that you will have many hours of great sailing and racing in this truly excellent design. The RS Toura is an exciting boat to sail and offers fantastic sailability and performance. This manual has been compiled to help you to gain the maximum enjoyment from your RS Toura, in a safe manner. It contains details of the craft, the equipment supplied or fitted, its systems, and information on its safe operation and maintenance. Please read this manual carefully and be sure that you understand its contents before using your RS Toura.

This manual will not instruct you in boating safety or seamanship. If this is your first boat, or if you are changing to a type of craft that you are not familiar with, for your own safety and comfort, please ensure that you have adequate experience before assuming command of the craft. If you are unsure, RS, your RS Dealer, or your national sailing federation – for example, the Royal Yachting Association – will be able to advise you of a local sailing school, or a competent instructor.

RS Sailing highly recommends using RS supplied equipment for usage and storing of your craft. Deviation from using RS supplied equipment, such as sails and storage solutions, will require consultation with RS Sailing. Failure to do so may affect Warranty claims and Goodwill outcomes

**For further information, spares, and accessories, please contact:**

RS Sailing  
Premier Way  
Abbey Park  
Romsey  
Hampshire SO51 9DQ  
Tel: +44 (0)1794 526760  
Email: [info@RSSailing.com](mailto:info@RSSailing.com)

**For details of your local RS Dealer, please visit [www.RSSailing.com](http://www.RSSailing.com)**



### 3 - Preparation

Your RS Toura comes complete with all the components necessary to take the boat sailing. In order to commission it, you will need the following tools:

- Pliers or a shackle key
- Small, flat-bladed screw driver
- PVC electrician's tape
- Pozi-drive screwdriver
- Adjustable spanner (small)

**Including adding a spinnaker system please allow three hours to fully prepare your RS Toura.**

**Whilst your RS Toura has been carefully prepared, it is important that new owners should check that shackles and knots are tight. This is especially important when the boat is new, as traveling can loosen seemingly tight fittings and knots. It is also important to check such items prior to sailing regularly.**

**To simplify the commissioning process, please take care when unpacking the items from the boat as cross contamination of pack contents can cause confusion. A calm and orderly environment will assist the process.**

# **RS** Toura

## Rigging Guide

### 4 - Hull



PLEASE FOLLOW RIGGING GUIDE IN CORRECT ORDER

**RS**  
Toura

Start by attaching the toestraps to the thwart across the middle of the cockpit.

To do this you will need a pozidrive screwdriver.

Make sure you attach the toestraps the right way round. The ends with the webbing loop attach to the thwart. The ends with the buckle **DO NOT** attach to the thwart.

The forward toestraps are separate and the aft toestraps are joined together in a V shape.

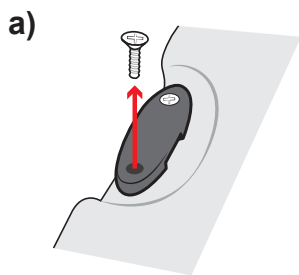
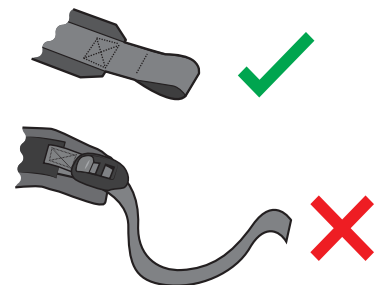
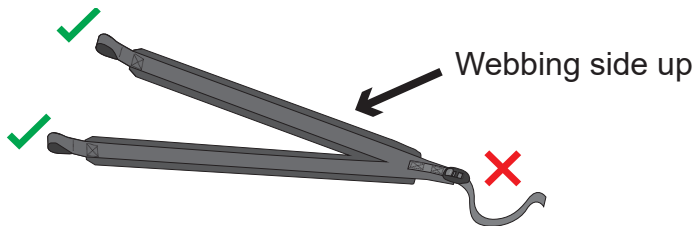
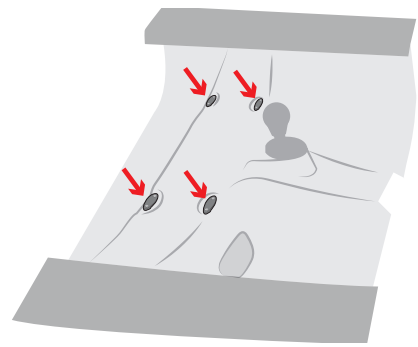

Remove **ONE** of the screws from the toetraps retainer on the thwart.

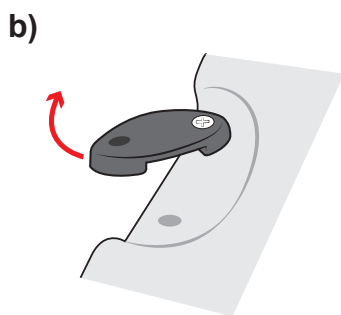

Rotate the toetraps retainer outwards to allow you to slide the webbing loop on the toetraps over it.

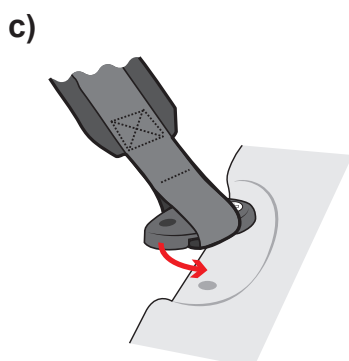
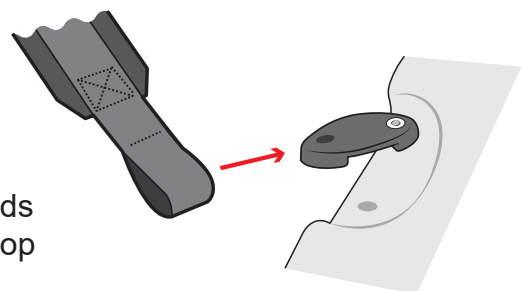

Rotate the toetraps retainer back into position and replace the screw.

Repeat for all four toetraps retainers on the thwart.

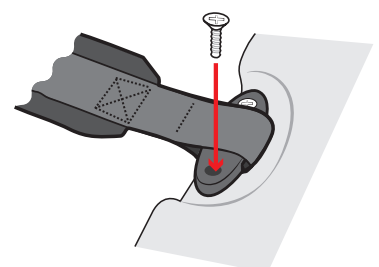

**RS**  
**Tourea** 4.1 - Toestraps

d)

You can now attach the two forward toetraps ends and one aft toetraps end to the toetraps retainers using the buckle.

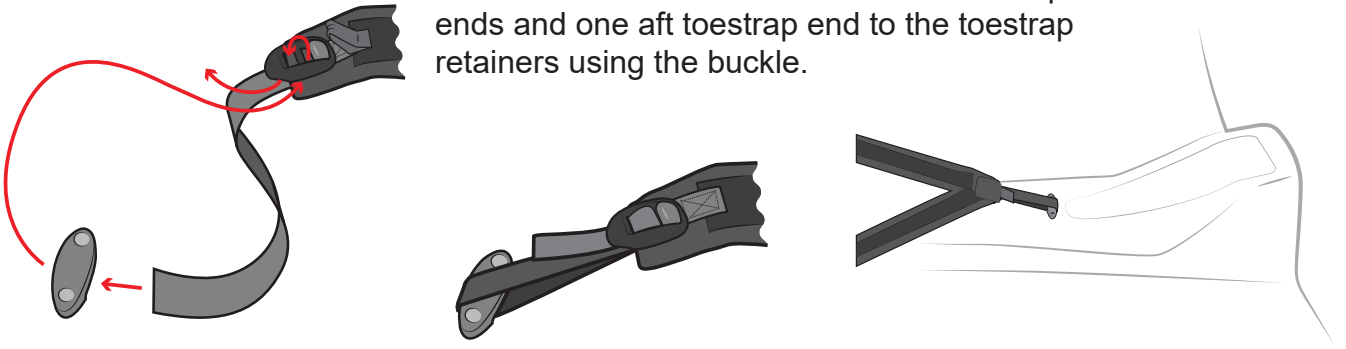

e)

There are two elastics emerging from the track on the mast support beam. Using a knot on knot, tie one of these elastics to each of the front toetraps through the webbing loop behind the buckle.

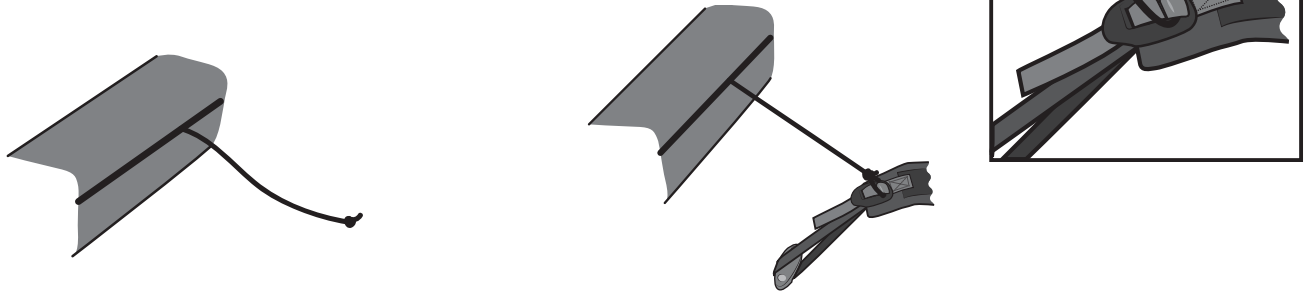

**RS**  
**Tourea** 4.2 - Shroud eye bolts

a)

Find the two shroud eye bolts and recess bars in the customer kit.

Hold the recess bar beneath the gunwhale and make sure the holes are aligned

Screw the shroud eye bolt through. Tighten by hand and then give one further turn using a screwdriver through the shroud eye bolt.

Repeat on the other side of the boat.

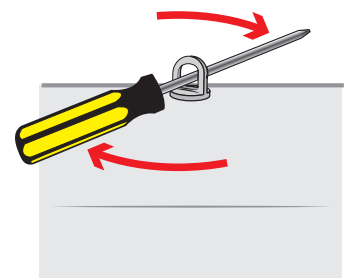
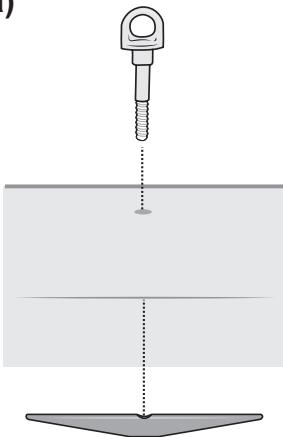

b)

Add the shroud adjuster plates through the shroud eye bolts on either side of the boat. Secure through the bottom hole using the M5 nut and bolts supplied. Temporarily attach the clevis pin and split ring in hole 3.

Start at hole 3

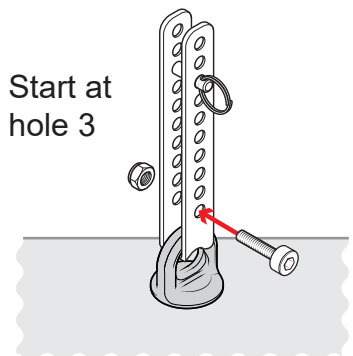
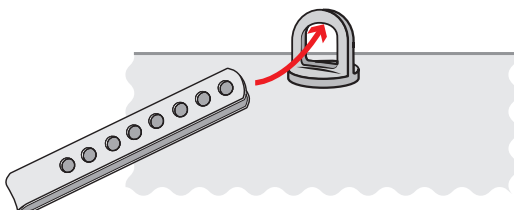

### 4.3 - Asymmetric spinnaker fittings.

If you have purchased the asymmetric spinnaker pack **(which is available as an option)**, there are a number of fittings that must be added before you can rig the boat.

To complete this section you will need:

- Asymmetric spinnaker kit
- Pozidrive screwdriver

#### a) Spinnaker Rear Halyard Block

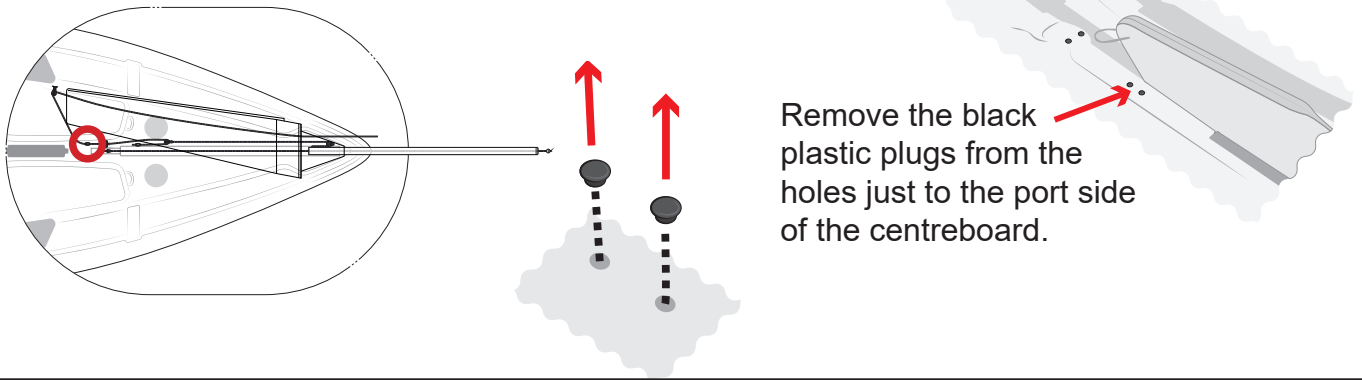

- b) Screw a 30mm stand-up block from the asymmetric spinnaker kit into these holes using the two M5 x 8mm bolts provided.

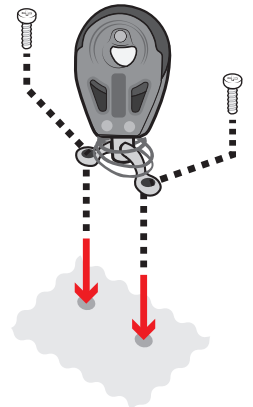
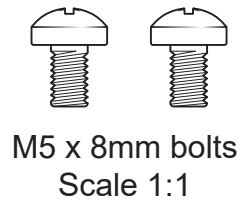

NOTE: You may have to slightly adjust the metal strap to align the holes. Use a pair of pliers or similar.

#### c) Spinnaker Halyard Cleat

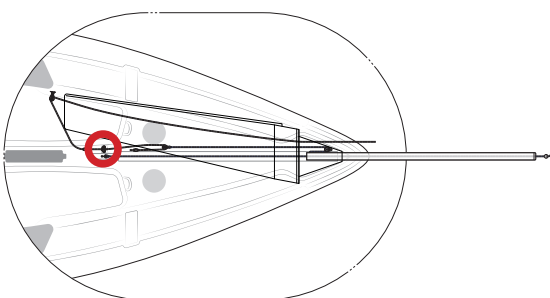

Remove the next set of black plastic plugs from the holes just forward of the centreboard.

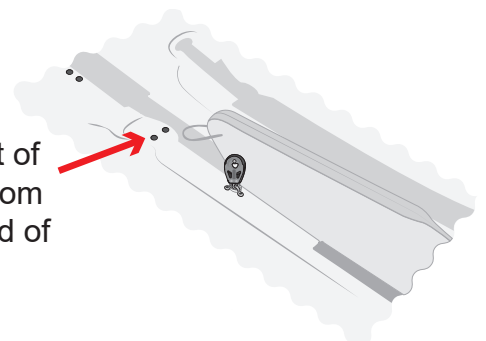

4.3 - Asymmetric spinnaker fittings.

d)

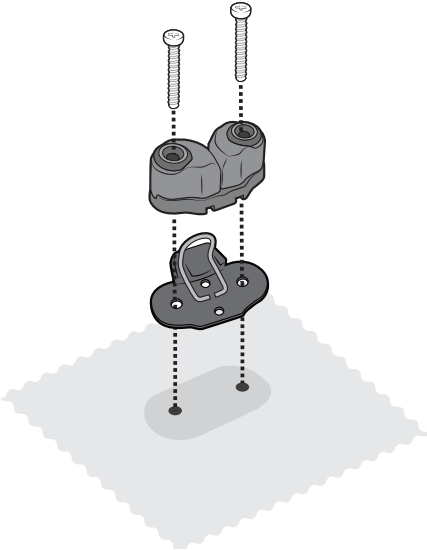

Attach the spinnaker halyard cleat using the M4 x 25mm bolts provided.

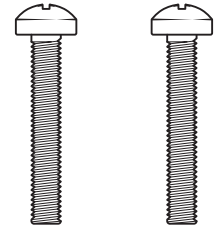

M5 x 25mm bolts  
Scale 1:1



Make sure cleat opens towards the stern of the boat.



If overtightened the jaws may not close properly.

e) Spinnaker Halyard Block Front.

Remove the plastic plugs from the next set of holes.

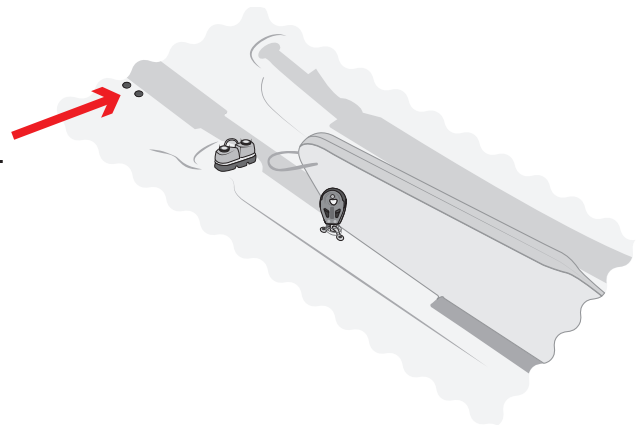
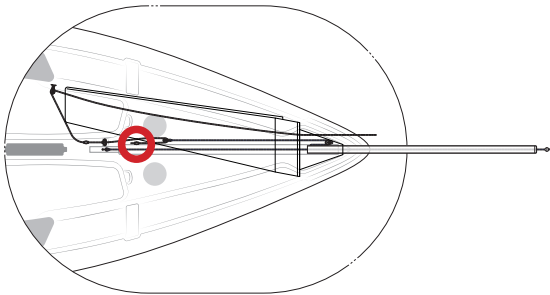

f)

Screw a 30mm block from the asymmetric spinnaker kit into these holes using the two M5 x 8mm bolts provided.

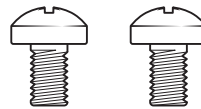

M5 x 8mm bolts  
Scale 1:1



NOTE: You may have to slightly adjust the metal strap to align the holes. Use a pair of pliers or similar.

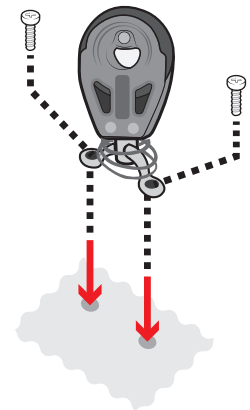

g)

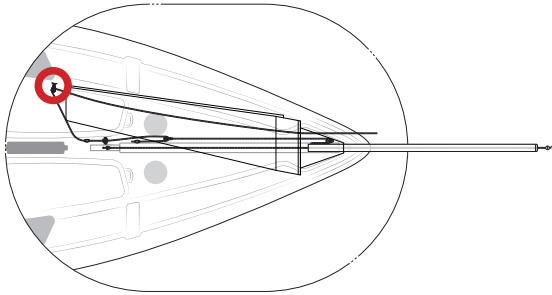

Remove the two black plastic plugs from the holes on the port side of the cockpit.

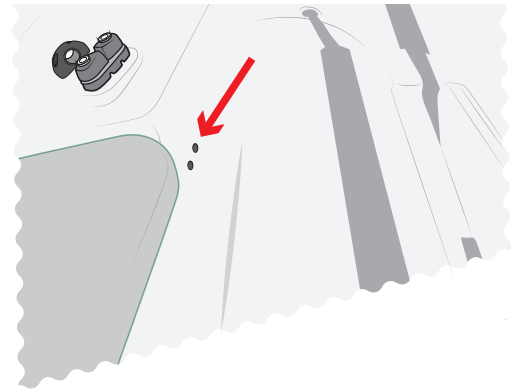

### h) Spinnaker Retrieval Block

Screw a 30mm block from the asymmetric spinnaker kit into these holes using the two M5 x 8mm bolts provided.

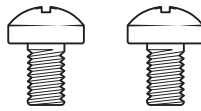

M5 x 8mm bolts  
Scale 1:1

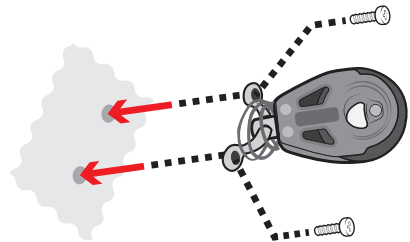

NOTE: You may have to slightly adjust the metal strap to align the holes. Use a pair of pliers or similar.

### i) Spinnaker pole outhaul block

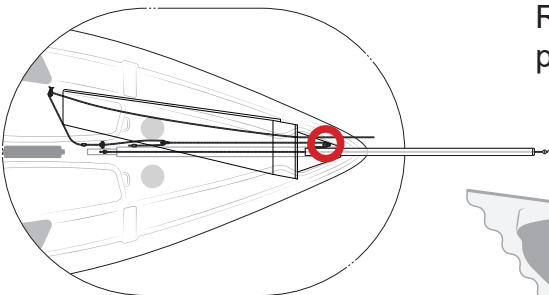

Remove the two black plastic plugs which are just to the port side of the front end of the spinnaker pole channel.

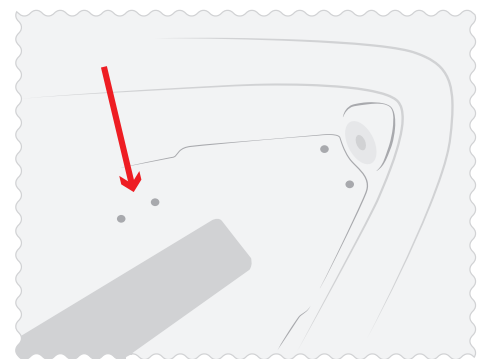
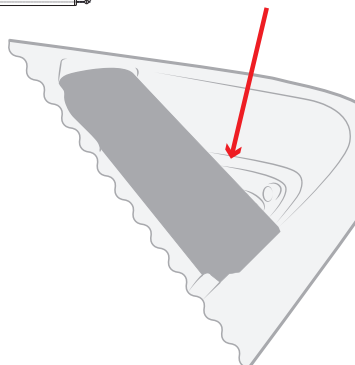

4.3 - Asymmetric spinnaker fittings.

j) Add the turning block using the screws provided.

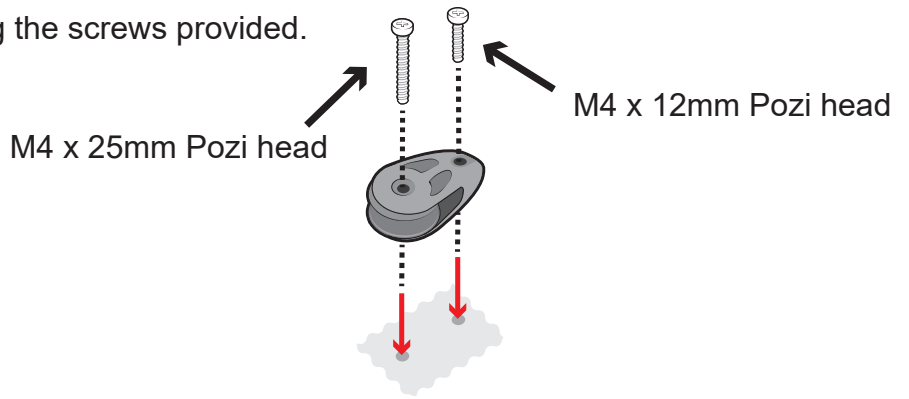
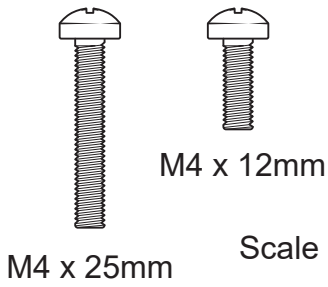

k) Tack Line Eyelet

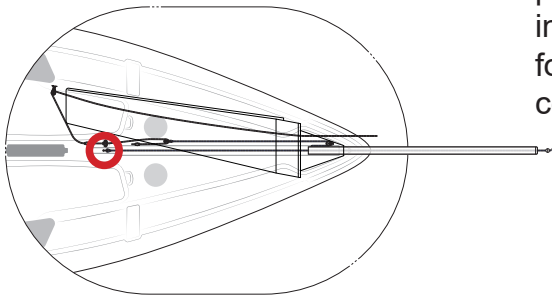

Remove the two black plastic plugs from the holes in the channel that runs forwards from in front of the centreboard case.

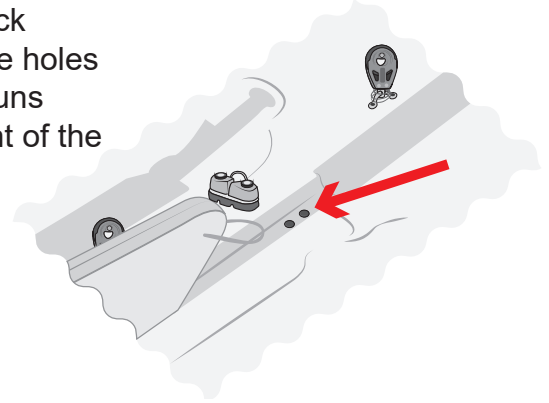

l)

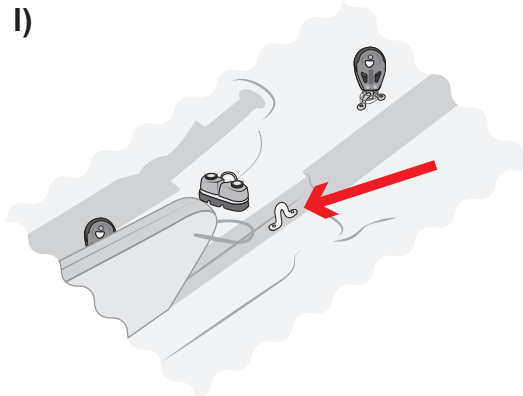

Add the metal eyelet from the asymmetric spinnaker kit using the two M5 x 8mm screws provided.

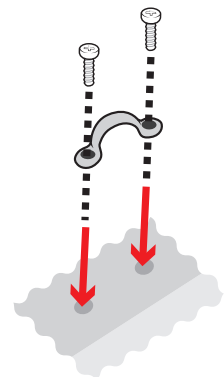
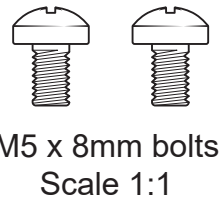

m) Adding the Spinnaker Pole

The inboard end of the bowsprit has two ropes emerging from it. The outboard end has one rope with a plastic stopper on it. In order to insert the inboard end into the boat you will have to remove the launch line (the rope coming out of the side). Insert the bowsprit, inboard end first, into the hole in the bow of the boat.



Once inserted you should reattach the launch line to the bowsprit.

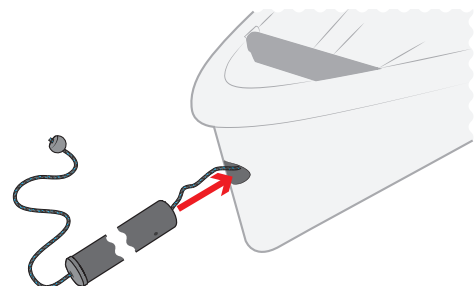
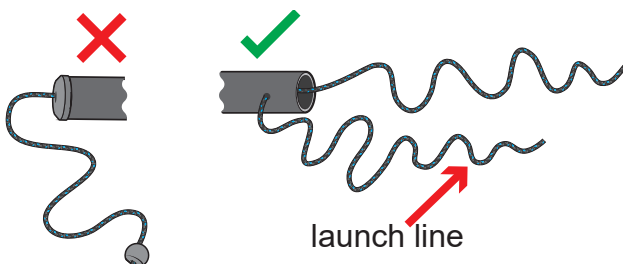



n) Rigging the Tack Line

Make sure that the bowsprit is fully extended.

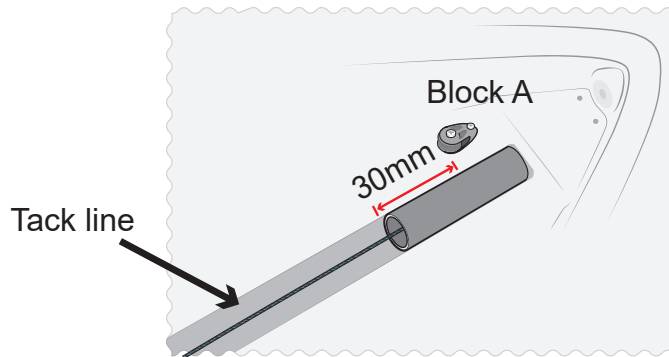

o)

Keeping the bowsprit fully extended, pull the tack line (that emerges from the inboard end of the bowsprit) tight and tie to the eyelet in the bottom of the bowsprit channel with a bowline.

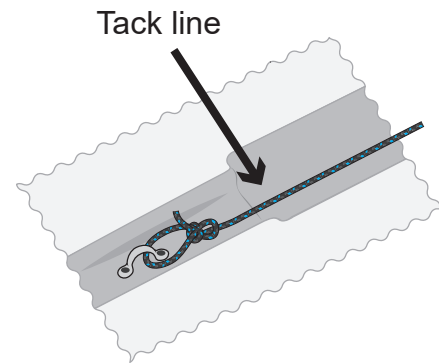

p) Rigging the Launch Line

Take the rope that emerges from the side of the inboard end of the bowsprit and feed it through block A at the bow (from starboard to port).

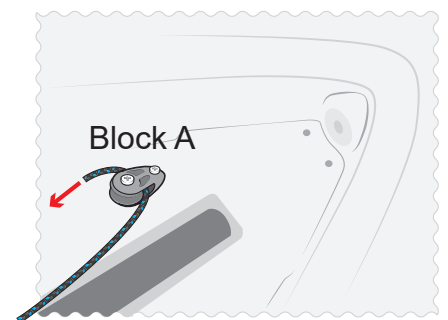
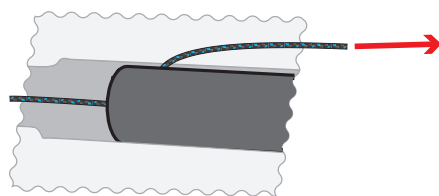

q)

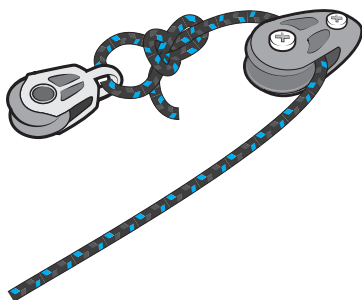

Tie a 30mm block from the asymmetric spinnaker pack onto the end of this rope using a bowline.

Adjust the stopper knot at the other end of this rope so that the bowsprit can retract fully into the boat without the 30mm block hitting block A.



Make sure the 30mm block does not meet up with the halyard block when the pole is extended.

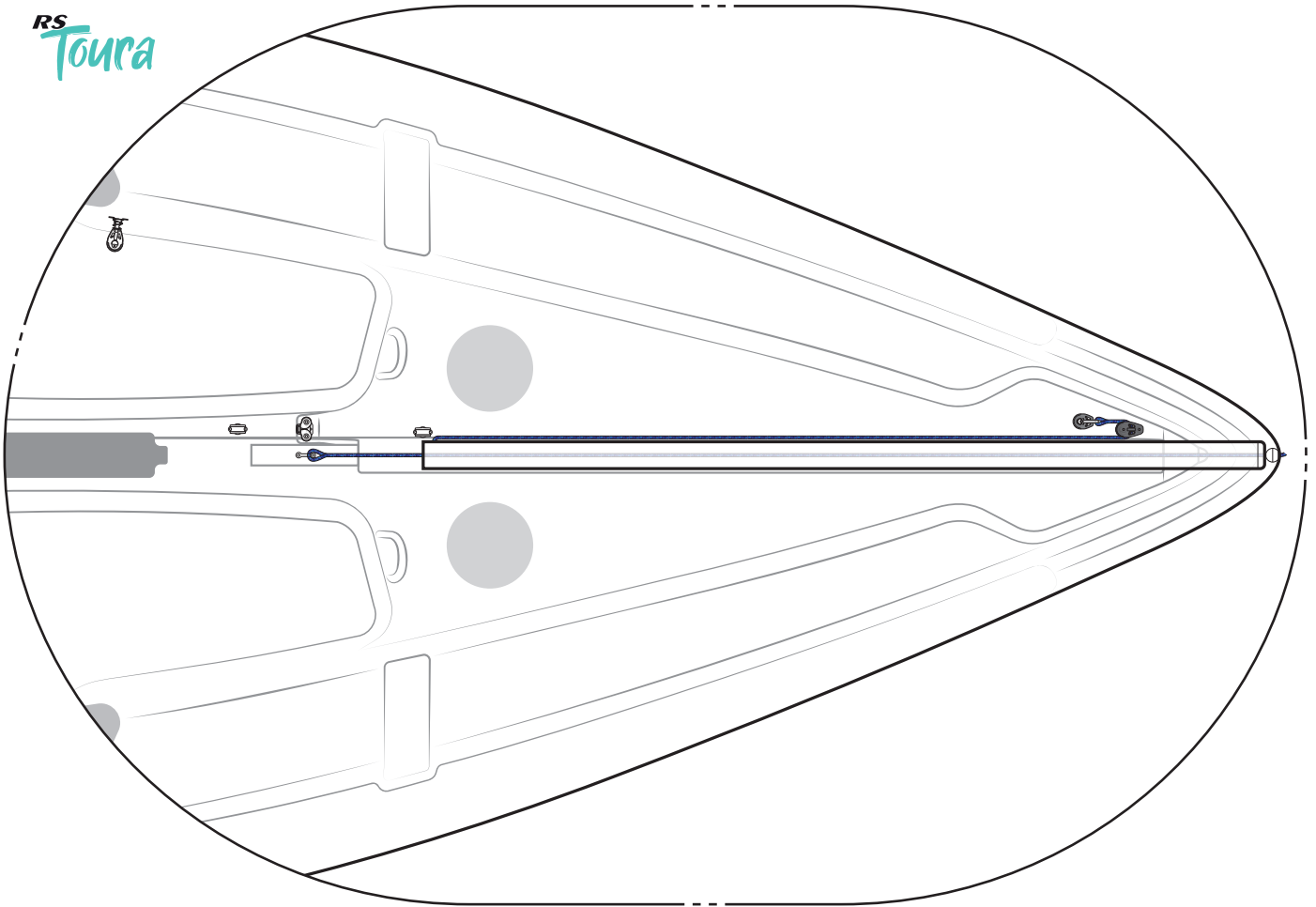

#### 4.5 - Adding the Spinnaker Sock

a)

Remove the two screws and washers from inside the spinnaker chute.

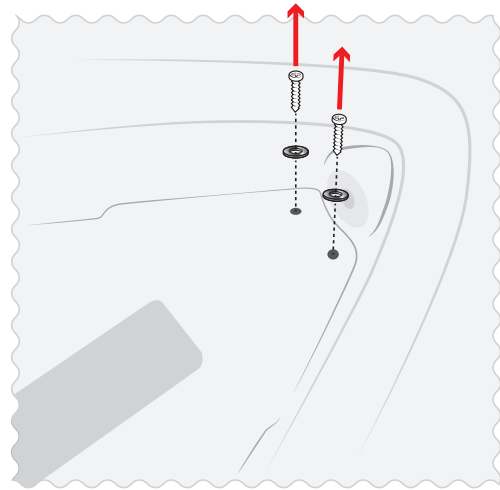

b)

Add the screws through the tongue of the spinnaker sock back into the holes that they came from.

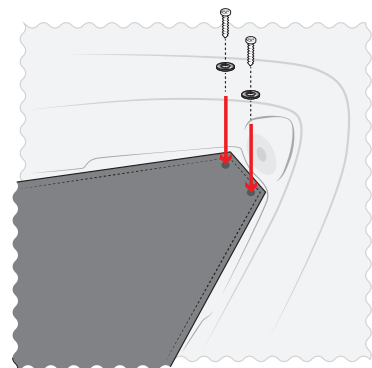

c)

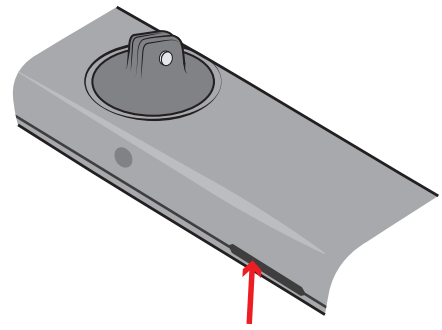
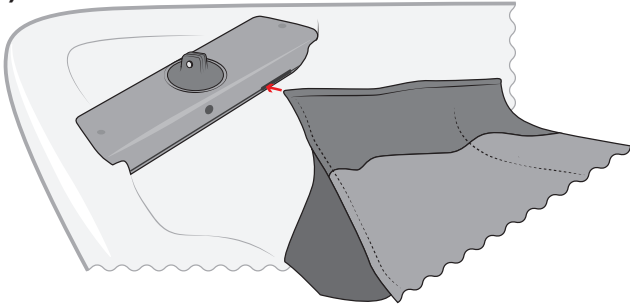

Slide the port side of the front edge of the spinnaker sock into the opening of the track on the tack bar.

d)

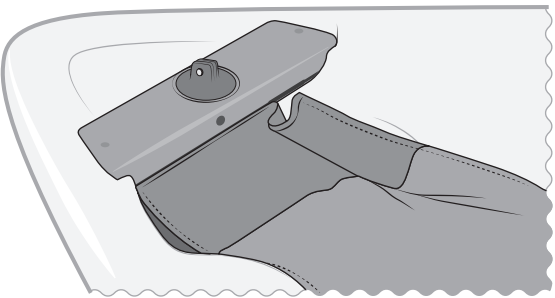
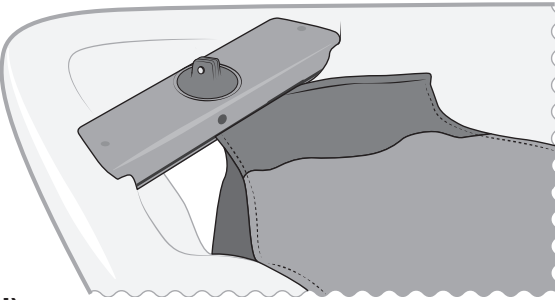

Make sure the port side is fully inserted into the track and then insert the starboard side into the track opening. This can be a little tricky as you will need to bend it back on itself to get to the opening, but as long as the starboard side is fully inserted first it shouldn't be too hard.

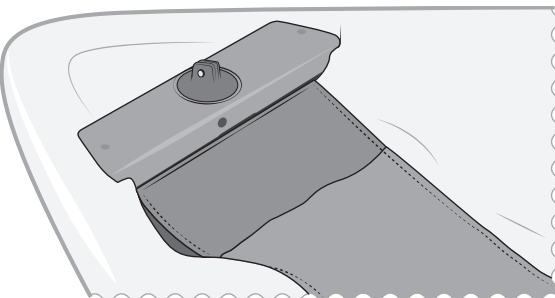

e)

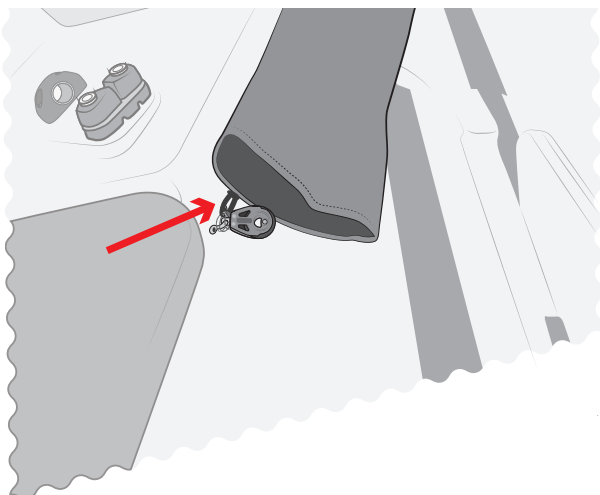

In the spinnaker pack there should be some elastic for the rear of the spinnaker chute.

Use this elastic to tie the aft end of the spinnaker chute to the eyelet (with the 30mm block on it) on the port side of the cockpit.

# RS

# Touira

## Rigging Guide

### 5 - Mast

To complete this section you will need:

- The mast and rigging packs
- A flat-bladed screw driver
- PVC electrical tape
- 8mm (or small adjustable) spanner



PLEASE FOLLOW RIGGING GUIDE IN CORRECT ORDER

# RS

# Touira

## 5.2 - Fitting the Spreaders to the Mast

It is worth taking time to ensure that this section is completed correctly. Improperly fitted spreaders will result in undesirable sailing characteristics, and may even result in failure of the mast.

- a) Carefully unpack the spreaders from the top of the mast, being sure not to damage any of the securing split rings.
- b) The shrouds and forestay are in the rigging pack.

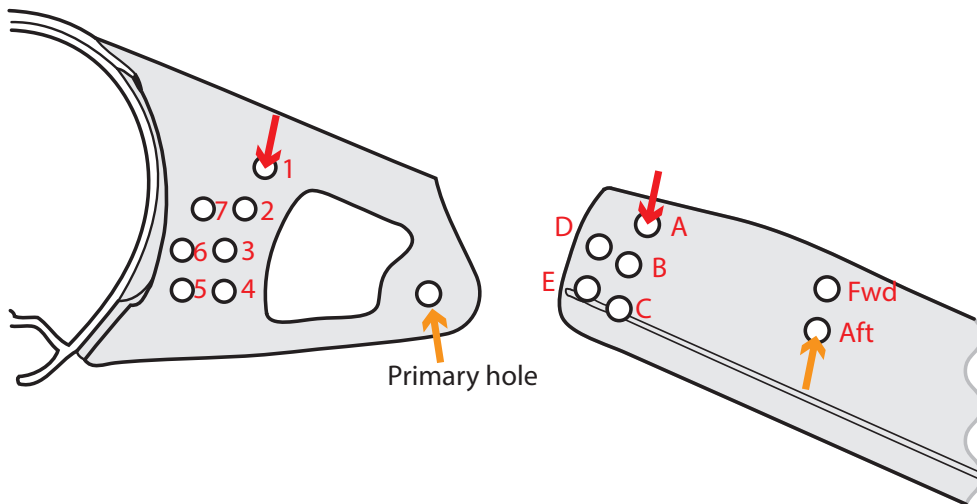

The Primary pin fits through the bracket's **primary hole** and through the **aft hole** in the spreader.

The Adjuster pin fits down through **hole 1** in the bracket and **hole A** in the spreader.



Tape up all the securing pins and rings to prevent them from being damaged, or from damaging the spinnaker.

## 5.3 - Attaching the Shrouds to the Mast

Attach the two shrouds to the mast.

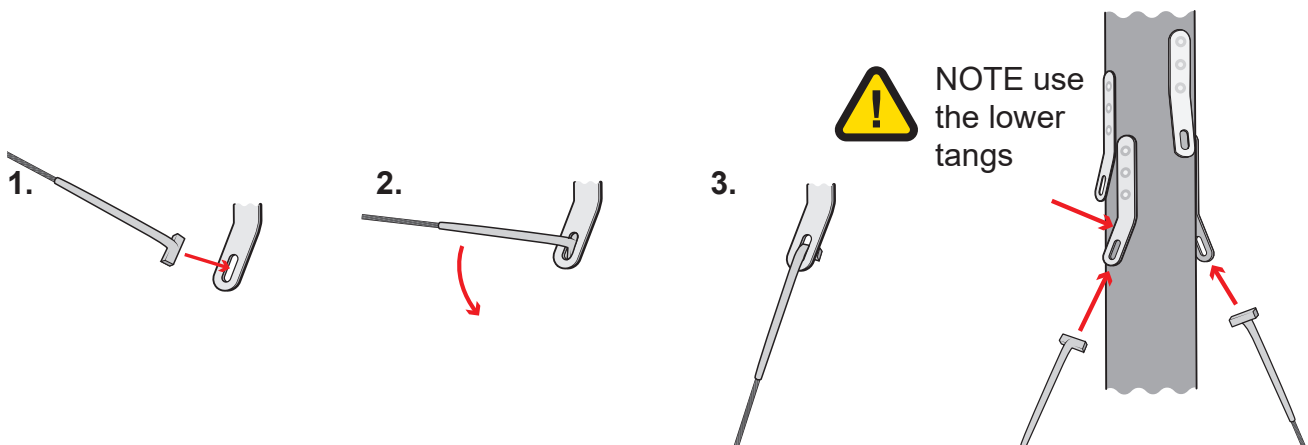

Insert the spreader ends into the spreaders, securing with a split ring. Wrap around the fixing with tape to prevent the sail being damaged.

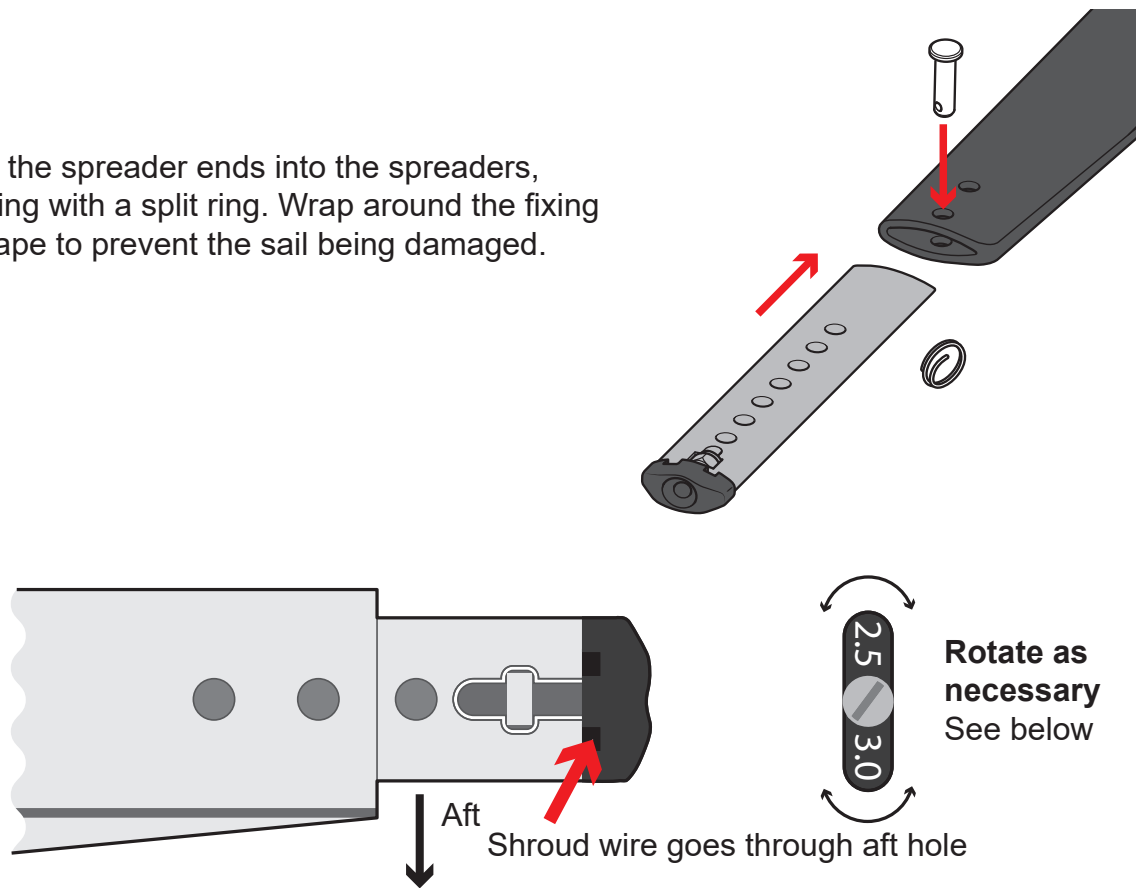

The spreader end cap incorporates two shroud wire slots to give a tight grip on either 2.5 or 3mm wire. The sizes are identified on the front face of the end cap (See diagram above). The RS Toura uses 3mm shroud wire so **the 3mm slot should be used.**

The end cap can also be rotated so that the shroud can be positioned at either the forward or aft position of the spreader end (see diagram above). **For the RS Toura the end cap should hold the shroud in the aft position.**

To attach the shroud, slacken the end screw, rotate the end clamp if necessary, then insert the shroud. Ensure that the shroud is tensioned between T-Terminal and spreader tip, then tighten the screw firmly.

This method “locks in” the dihedral angle.

Length Adjustment:

The position is described by the number of adjustment holes visible. **For the RS Toura there should be 1 hole visible as shown in the diagram above.**



All clevis pins and bolts must be fitted with the flat head on top, and the pins must be locked with a split ring.

Tape all split rings, pins and the outboard end of the spreader extrusion.



This will reduce chafe on the mainsail and prevent flailing sails/halyards becoming damaged. Self-amalgamating tape is best, but PVC electrical tape is an adequate alternative.

**RS**  
**Tourea** 5.5 - Main Halyard

a)

Feed one end of the main halyard into the track on the back of the mast through the opening above the gooseneck joint.

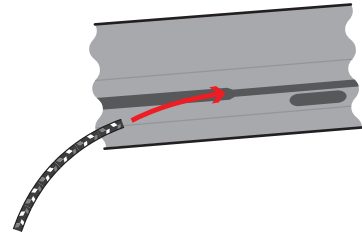

b)

Feed the main halyard the whole way up the mast, through the masthead fitting, around the turning block and back down the mast.

Top tip: It is much easier to thread the halyard up the mast if you put a small screwdriver or needle in through the track and into the rope to pull the end upwards.

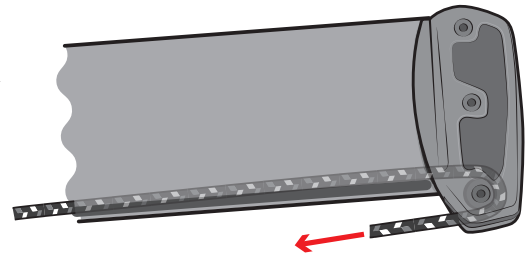

c)

Add the plastic bobble on the end of the rope. This will be used to attach to the sail.



Tie off both ends of the main halyard at the bottom of the mast so that they are easily accessible once the mast is stepped in the boat.

**RS**  
**Tourea** 5.6 - Jib Halyard

a)

For the Purchase Rig Tension system the Jib halyard will need to be fitted to the mast.

There will be a mousing line between the sheave at the top of the mast and the exit point at the bottom.

Attach the rope end of the halyard provided in the rigging kit to the mousing line at the top of the mast, we suggest using a sheep bend knot, then pull the rope down the mast until appears at the exit point.



Be very careful not to lose the halyard in the mast.

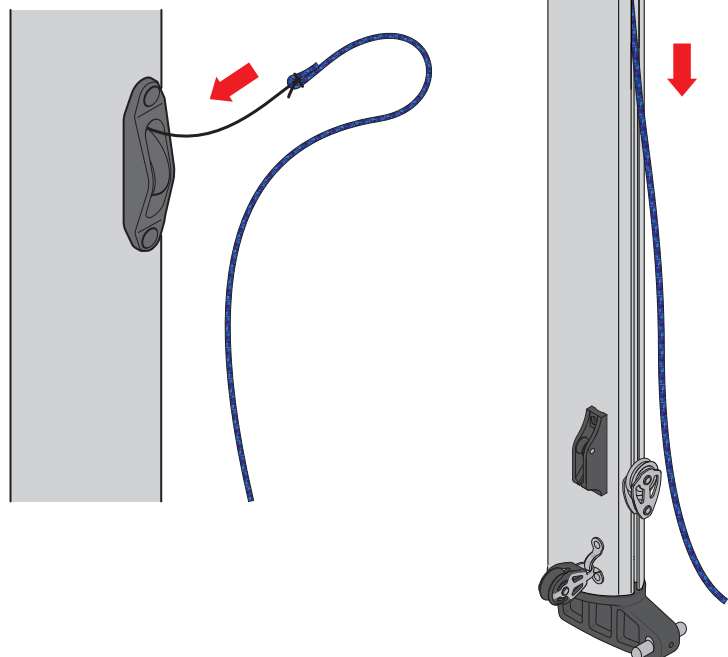

**RS**  
**Tourea** 5.6 - Jib Halyard

b)

Pull the wire end down to the base of the mast.

Tie a safety knot in the end of the halyard.



Tie off both ends of the jib halyard at the bottom of the mast so that they are easily accessible once the mast is stepped in the boat.

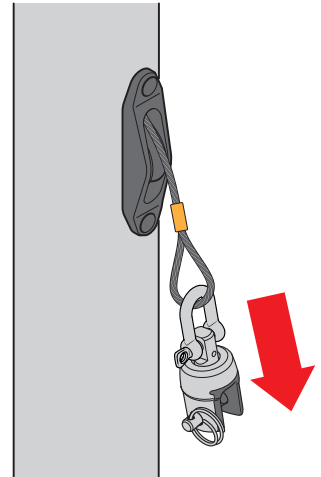

**RS**  
**Tourea** 5.7 - Forestay

a)

Attach the top part of the forestay to the mast.

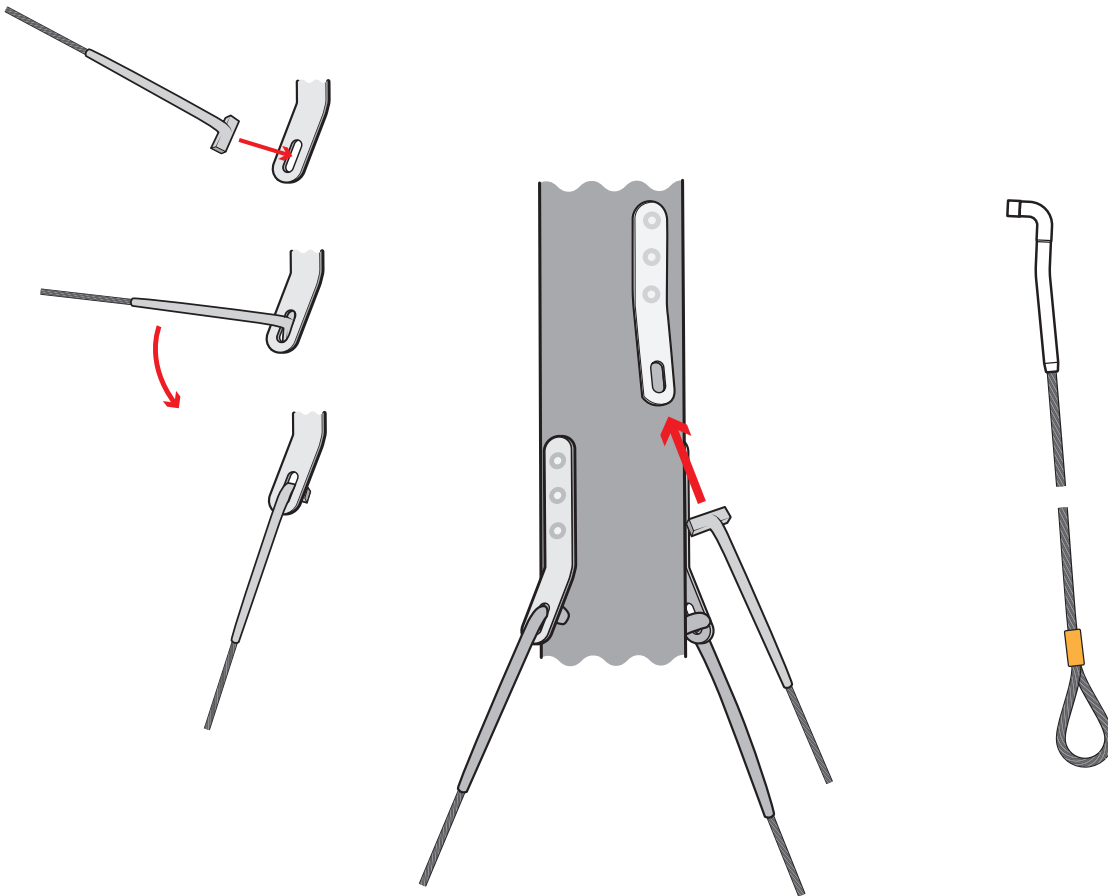



a)

Tie the metal ring to one end of the spinnaker halyard takeaway elastic found in the spinnaker pack using a knot-on-knot.



b)

Feed the other end of the spinnaker halyard takeaway elastic through the small ring on the front of the mast above the spreaders.

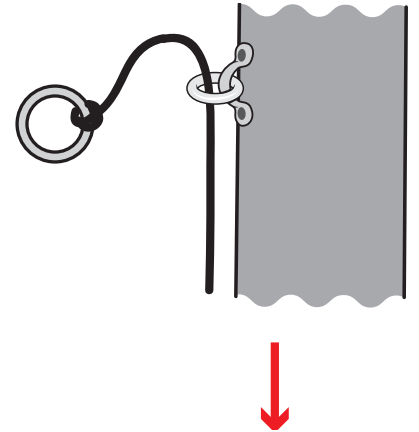

c)

Pass the end on the spinnaker halyard takeaway elastic down the mast and tie it through the hole in the mast step heel.



Make sure the elastic is tight enough that the ring on the end of it is tight against the small ring on the mast.

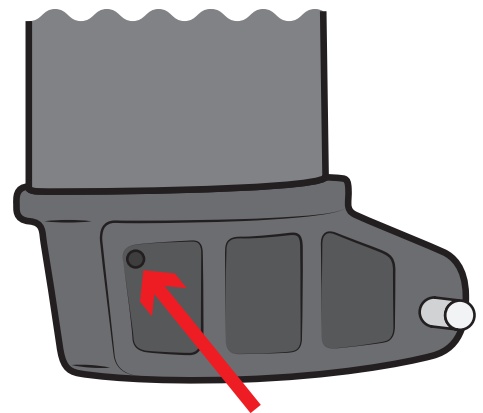

a)

Shackle the 30mm block for the spinnaker halyard to the eye closest to the mast head (just above where the shrouds and forestay join the mast).



Use pliers to tighten.

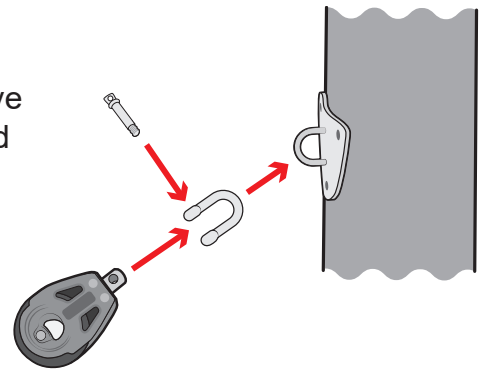

b)

Temporarily secure one end of the spinnaker halyard at the bottom of the mast. Once the mast is stepped in the boat this end will go to the front uphaul block.

Pass the other end of the spinnaker halyard up the mast, through the 30mm block and back down the mast.

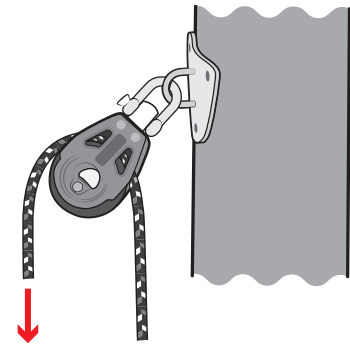

c)

Pass the end of the spinnaker halyard down the mast and through the metal ring on the end of the takeaway elastic.

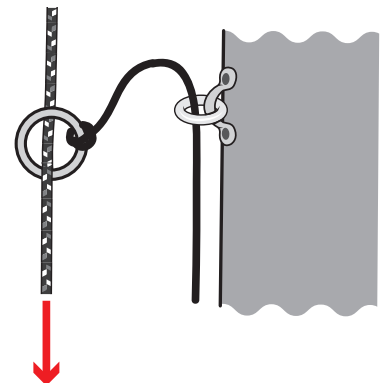

d)

Add the plastic bobble on the end.

When rigged, this end will attach to the head of the spinnaker.



Temporarily tie off both ends of the spinnaker halyard at the bottom of the mast so that they are easily accessible once the mast is stepped in the boat.

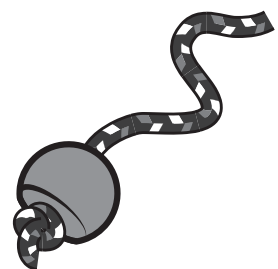

If you wish to fit the optional trapeze kit you must do this before stepping the mast. See Section 12 for instructions.

## 5.10 - Attaching the Masthead Float (optional)

If you have purchased the optional masthead float, you will have to fit it before stepping the mast in the boat.

- a) Attach the bracket to the masthead float using the four bolts provided.

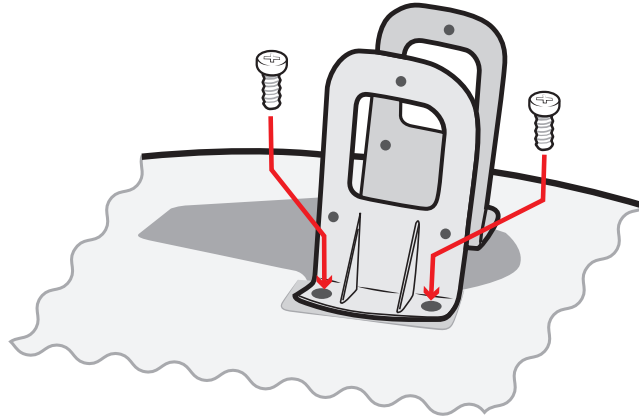

- b)

Slide the masthead float onto the mast.

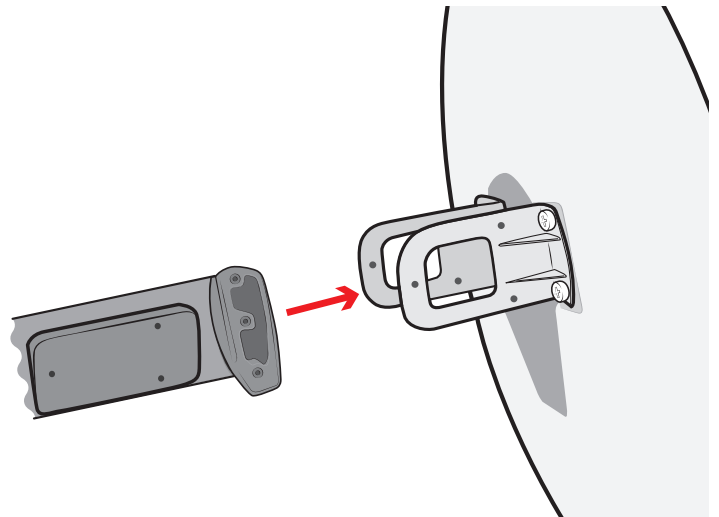

- c)

Make sure you have lined up the up the holes on the bracket, mounting plate and mast, then attach it using the 6 screws provided.

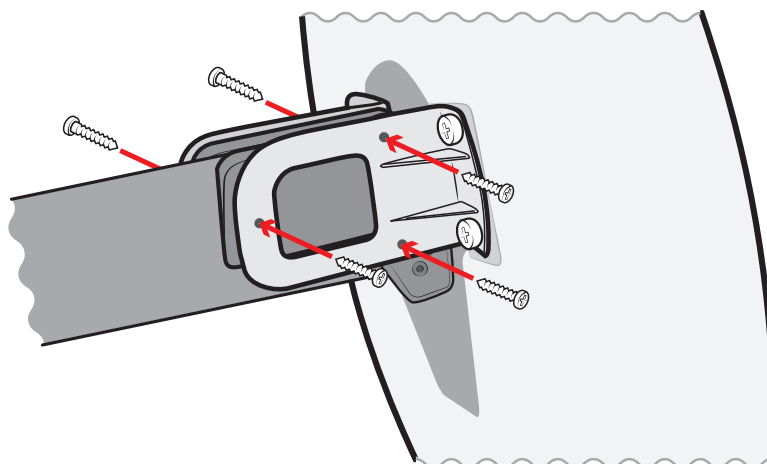



**BEFORE PICKING UP THE MAST, CHECK THAT YOU ARE NOT IN THE VICINITY OF OVERHEAD POWER CABLES**

- a) Before stepping the mast, familiarise yourself with how the “foot” (bottom end) of the mast will fit into the “step” (fitted to the boat).

Locate the mast foot in the mast step and lay the mast in the boat.

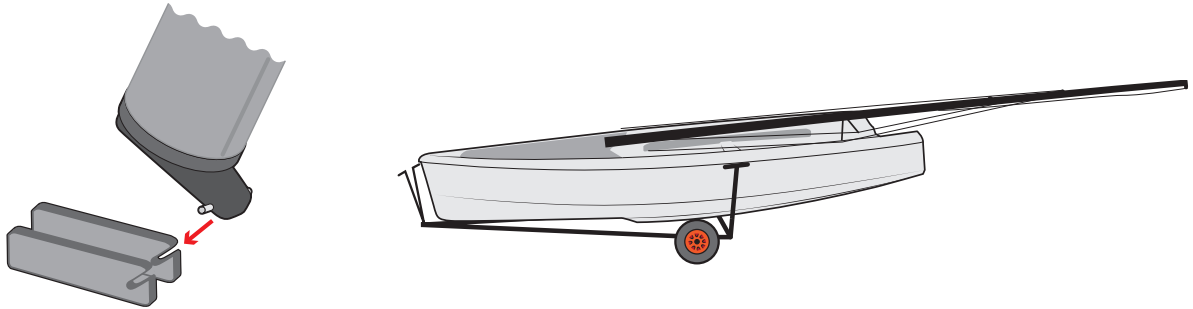

- b)

Slip the neoprene boot up the shroud, pointed end to the top.

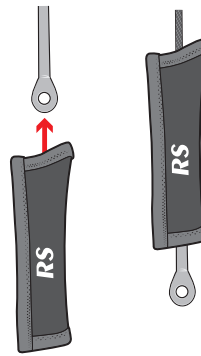

- c)

If not already fitted, slide the adjuster plate onto the shroud eye bolt.

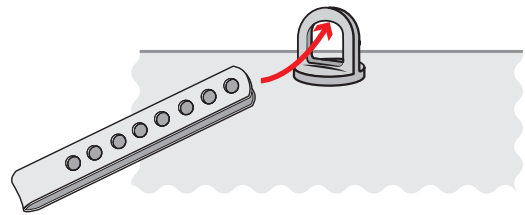

- d)

Attach the shroud to the middle of the shroud adjuster plate with the clevis pin and split ring provided.

**In light winds use hole 2 or 3.**

**In strong winds use hole 4, 5 or 6.**

Push the pin in from outboard towards the centreline of the boat.

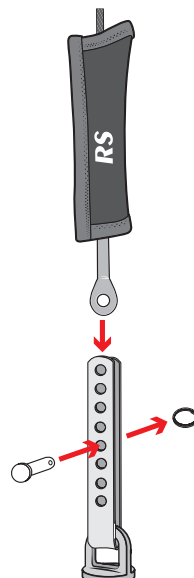

Wrap PVC electrician’s tape around the split rings for security, and to avoid snagging. This is particularly important if you don’t have the neoprene vernier covers.

e)

If using hole #4,5 or 6 use the M5 bolt and Nyloc in the top hole of the Vernier. Make sure the shroud passes outside the bolt.

If using hole 2 or 3 use of the bolt is not required



Ensure that the thread goes well into the nyloc of the nut, but do not bend the Vernier.

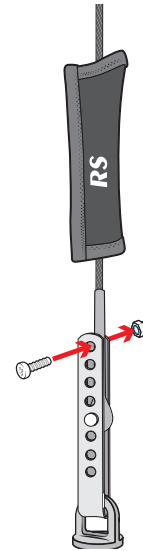

f)

Slide the boot down over the vernier.



g) Repeat **steps a-f** on the other side of the boat.

Ensure that the forestay is fitted correctly and loose at the lower end. Ensure all 3 halyards are tied to the eye on the front of the mast.



**BEFORE STEPPING THE MAST, CHECK THAT YOU ARE NOT IN THE VICINITY OF OVERHEAD POWER CABLES**

Now the mast is ready to be put up in the boat, or “stepped”.

### REMEMBER

Check that both ends of the main halyard, jib halyard, and spinnaker halyard are tied off at the bottom end of the mast so that they are within easy reach when the mast is stepped.

Fig. 1

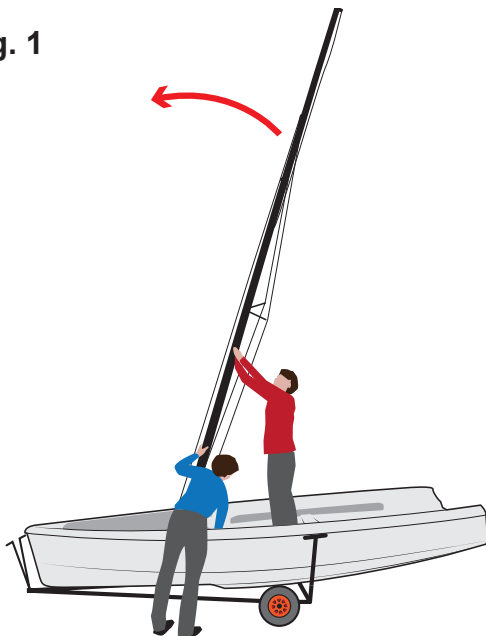
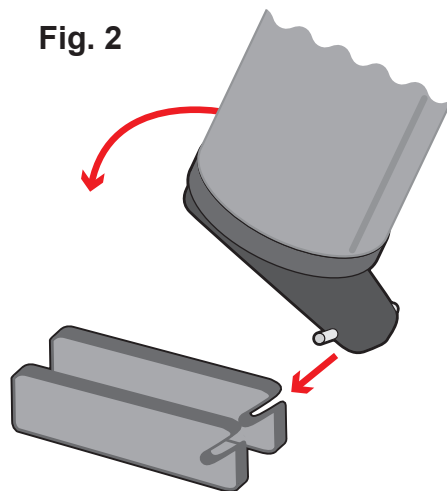

Fig. 2



**Note:** It is recommended that the mast should always be stepped with 2 people. If the wind is blowing, there will be a lot of pressure at the top of the mast making it wave around. Consider finding a second helper if you feel you will struggle!

- a) Pass the mast, foot first, into the boat over the stern so that the foot lines up with the mast step. **See Fig.1**

- b) One person inside the boat should line the foot of the mast up correctly with the mast step so that the pins on either side slot into the grooves of the mast step. **See Fig. 2**

- c) You can now lift the mast with one person inside the boat and another helping from outside the boat until the mast is upright.

Once the mast is vertical attach the forestay



If the boat is in a trolley, do not walk aft of the balance point!

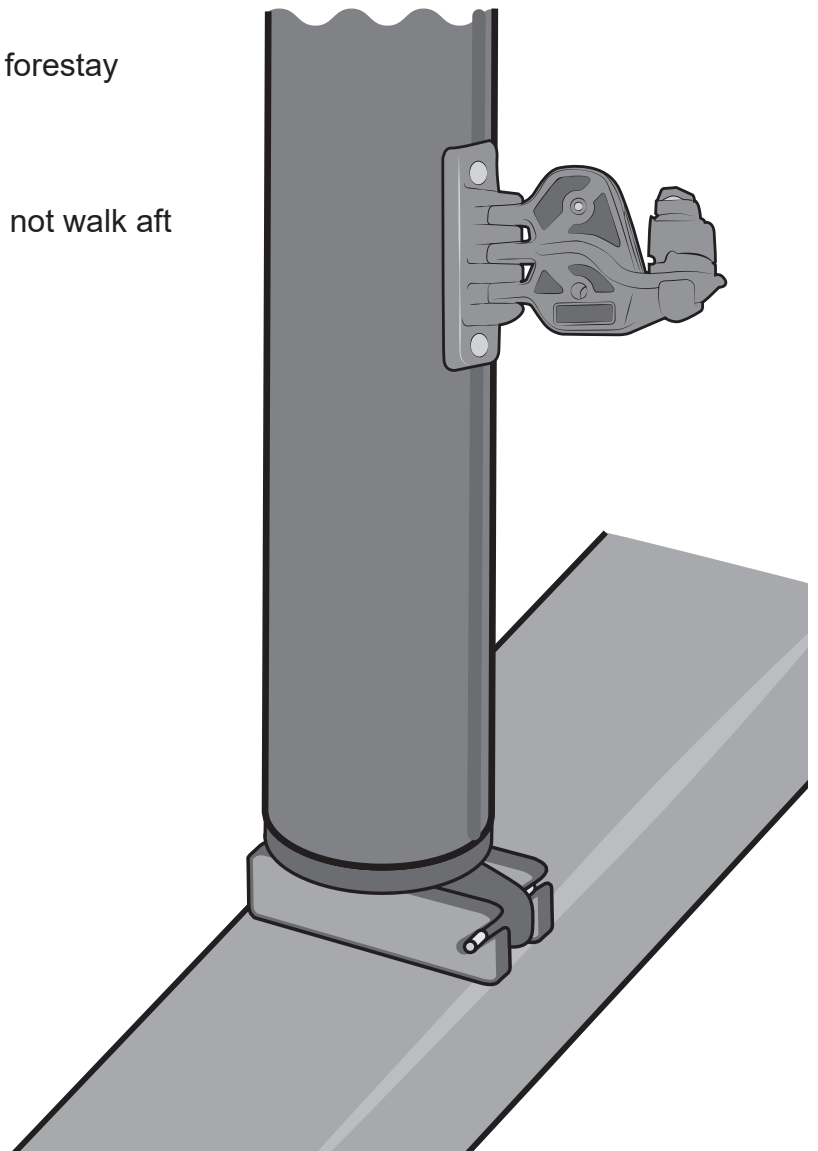

**d) Forestay - Rig Tension - Purchase System**

Attach the lower part of the forestay to the deck clip on the jib furler beam using the rope provided, several loops will be needed, then tie off.

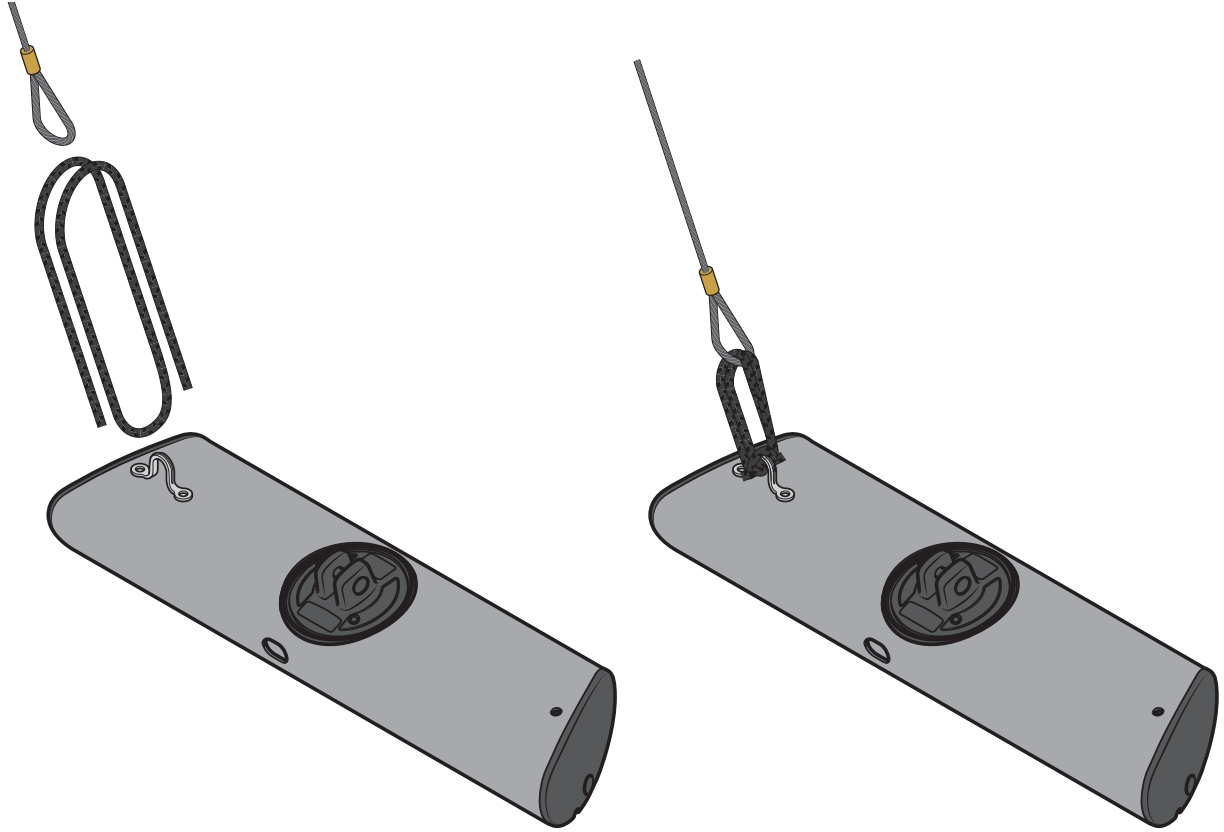



# **RS** Toura

## Rigging Guide

### 6 - Boom



PLEASE FOLLOW RIGGING GUIDE IN CORRECT ORDER

**RS**

Toura

## 6.1 - Fitting the boom

To complete this section, you will need:

- The boom
- The gnav bar

a)

Connect the gnav bar to the slider at the front end of the boom.

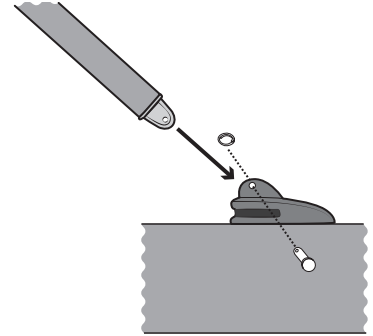

b)

Open the drop nose pin then connect the front of the boom to the gooseneck on the mast.

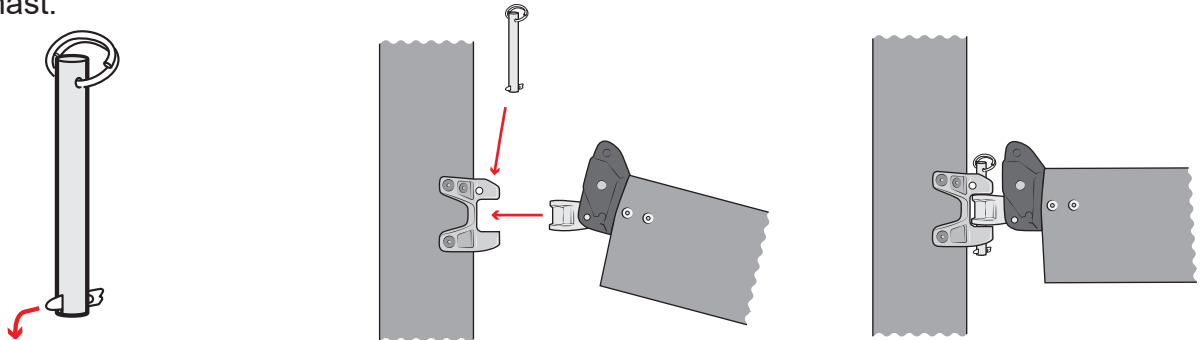

c)

Connect the upper end of the gnav bar to the bracket on the mast above the gooseneck.

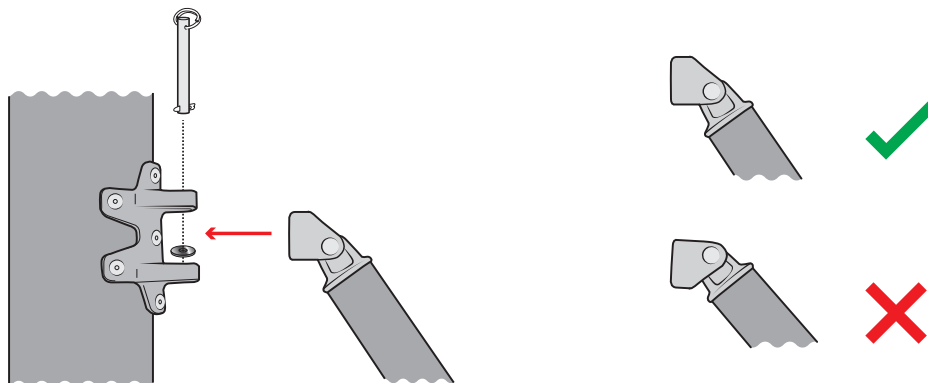

It is vital that the gnav toggle is inserted as shown above. Failure to do so will result in damage to the strut assembly.

Feed the gnav control line down through the swivel block and through the cleat below the boom. Tie a stopper knot in the end of the rope.

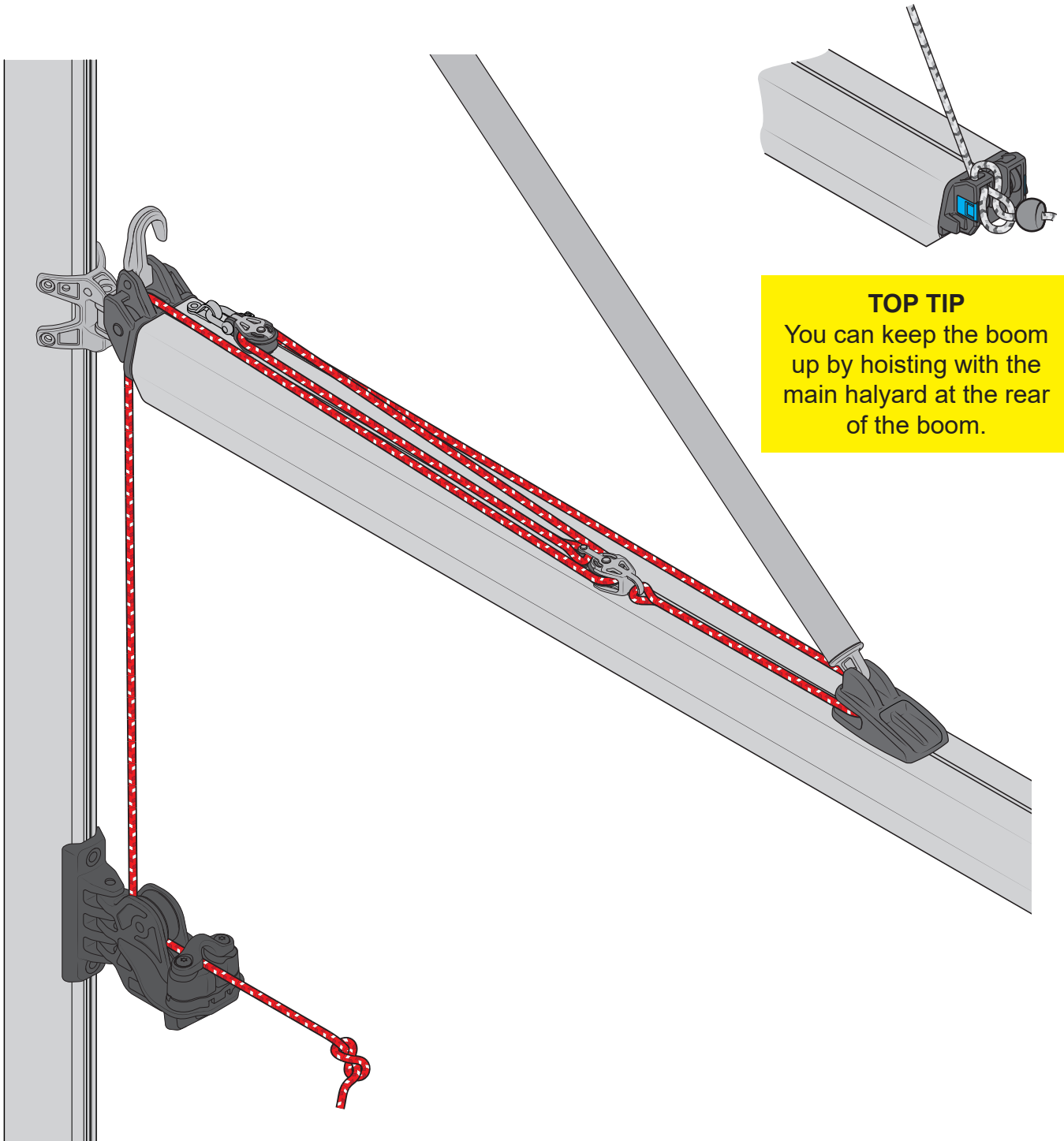
**TOP TIP**

You can keep the boom up by hoisting with the main halyard at the rear of the boom.

**a) Rigging the Mainsheet Strop**

Find the 40mm block with a becket and the mainsheet strop from the rope pack.

Take the mainsheet strop and fold it in half to form a loop.

Pass this loop through the base of the block.



**b)**

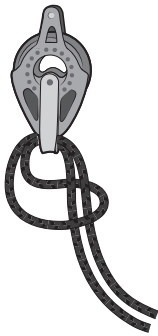

Pass the two tails of the rope back through the loop, making sure the block is in the middle.

**c)**

Pass each tail of the rope through the plastic fittings on the aft side of the thwart and tie a stopper knot.

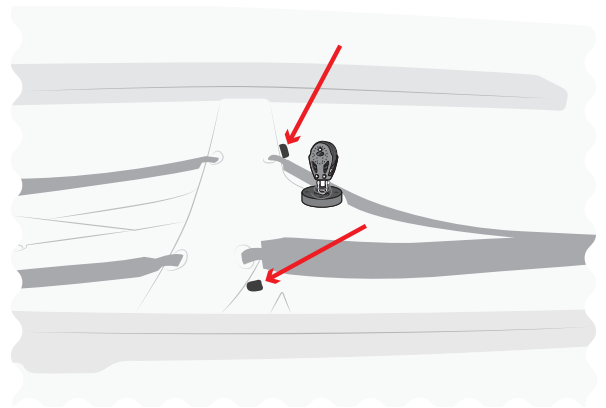

d)

Tie one end of the mainsheet to the becket on the mainsheet block (with a bowline) then thread through the blocks as shown.

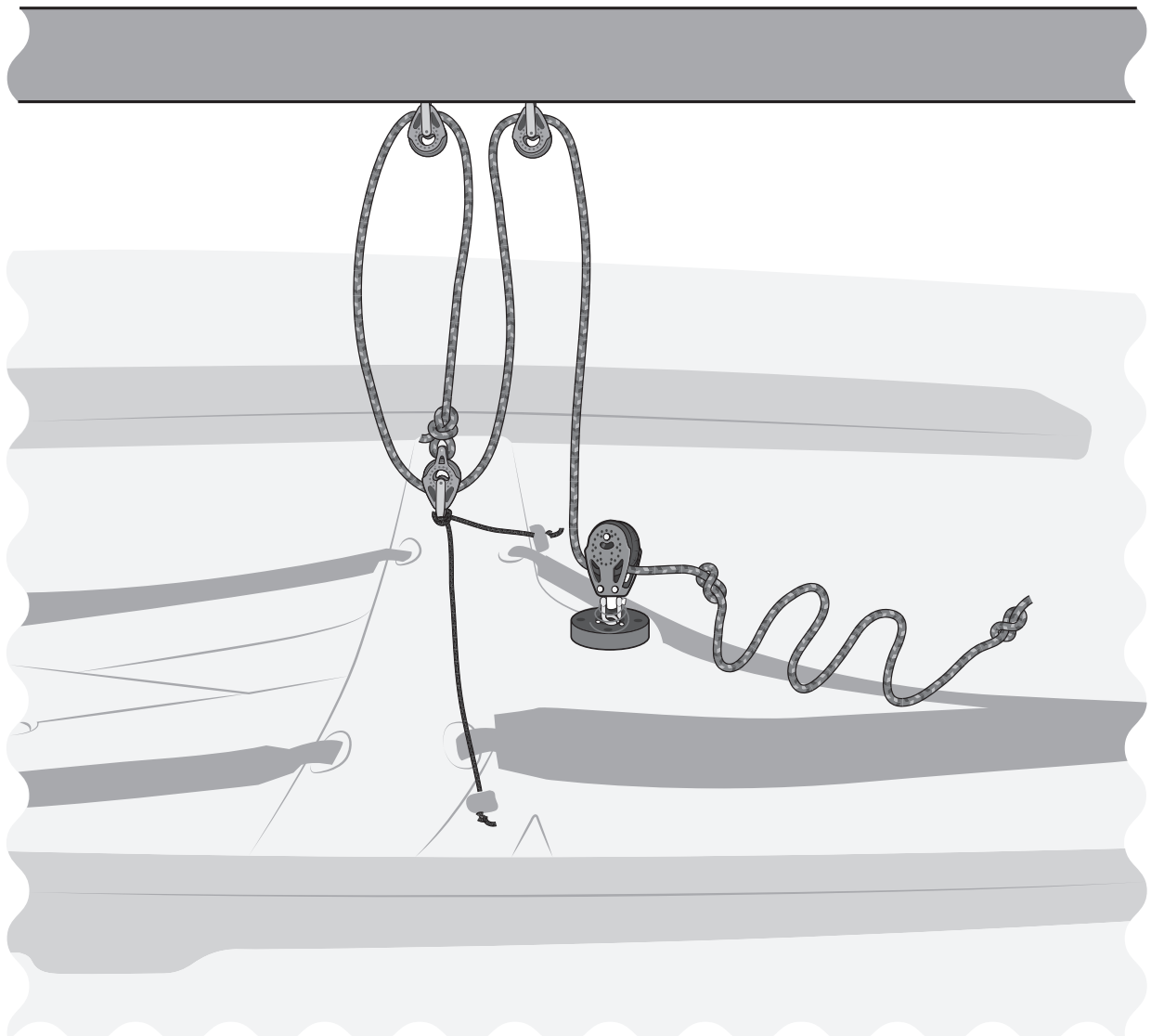

Tie a second knot in the mainsheet to prevent the boom from hitting the shrouds.

e)

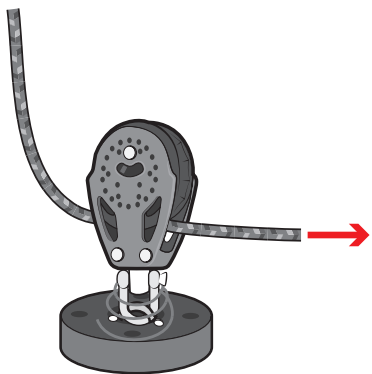

Pass the end of the mainsheet through block 4 (ratchet block).

Make sure you feed the rope through the correct way (as indicated by an arrow on the ratchet block).



Ratchet can be turned on and off with this switch.

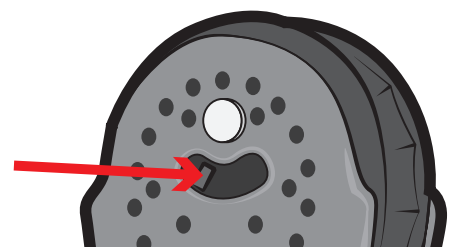

# **RS** Toura

## Rigging Guide

### 7 - Mainsail and Jib



PLEASE FOLLOW RIGGING GUIDE IN CORRECT ORDER

**RS**  
Toura

a)

Sail numbers should be supplied with each sail.

**1234567890**



Cut along dotted lines to form the correct sail numbers.

b)

Unroll your new sail. Stick the sail numbers on sail by following the measurements below.



NUMBERS MUST BE PLACED HIGHER ON THE STARBOARD SIDE.

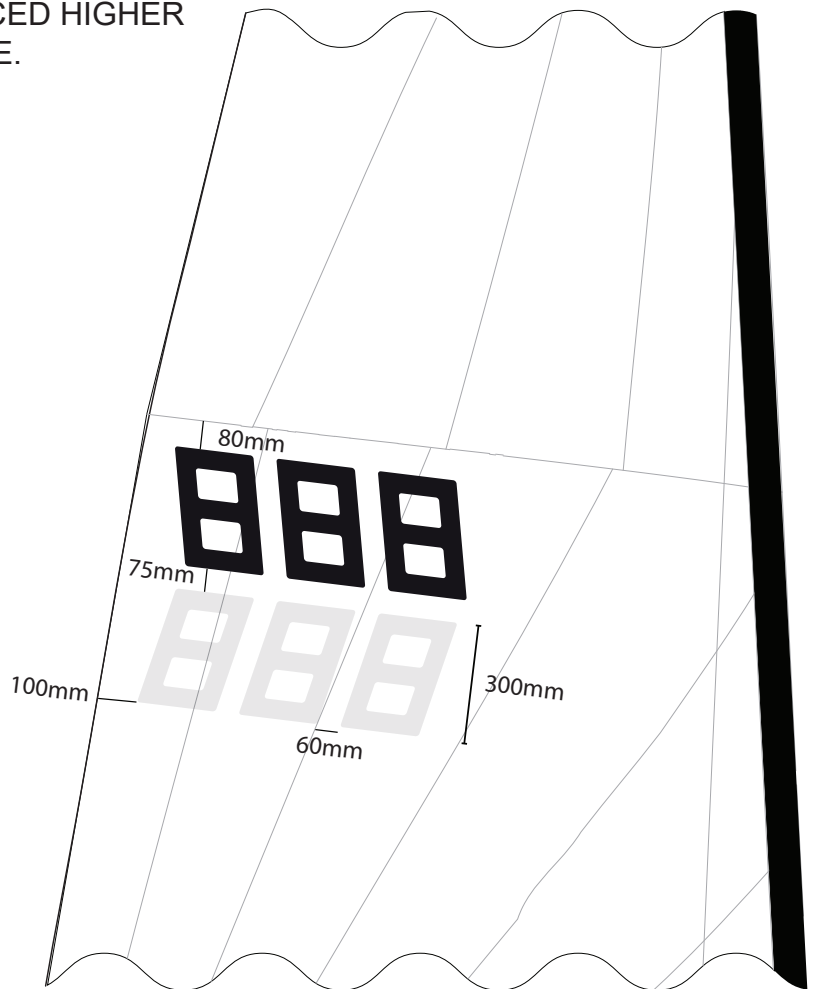
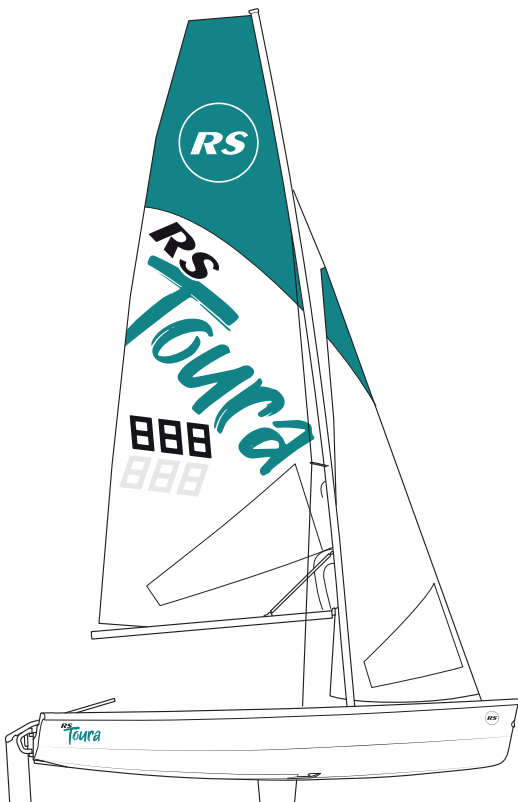

### 7.1 Preparing the Sails.

- c) There are also faint lines on the sail to show where to place the national letters (although these are optional and not supplied as standard.)

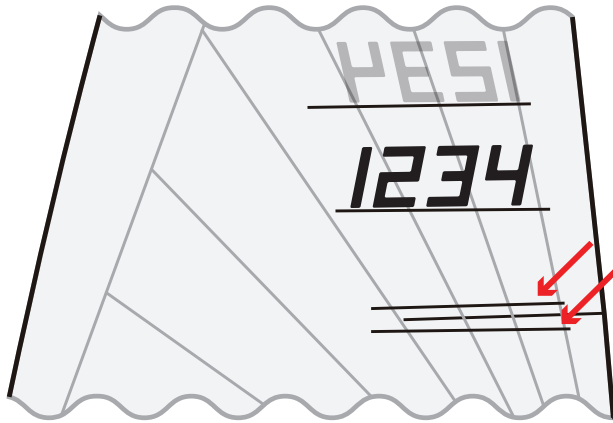

### 7.2 Battens

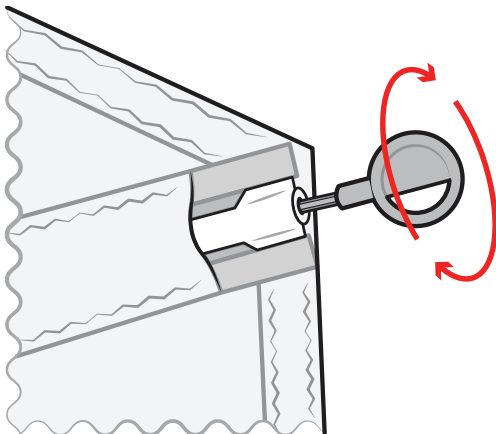

- Batten key should be on clew of sail.

Check the inboard ends of the battens are positively located in the inboard plastic end fitting. To tension, turn the key clockwise until the cloth becomes just tight. If it is over tightened you will have trouble tacking the head of the sail in light weather. Insufficient tension and the sail will set up too flat with wrinkles running down from the head.

### 7.3 Sail Care

Wash salt off sails after use and dry. Roll from the head. It is easier to fold the head in (as shown) so the top of the battens coincide before starting rolling. Store sail in its bag in dry conditions away from sunlight. Although the sail is made from a quality high denier fabric it is best to slightly slacken the top 2 battens' tension for long term storage.

When using a new sail for the first time, try to avoid extreme conditions as high loads on new sailcloth can diminish the racing life of the sail.

If your sail is stained in any way, try to remove it using a light detergent and warm water. DO NOT attempt to launder the sail yourself. A sail can be temporarily repaired using a self-adhesive cloth tape, such as Dacron or Mylar. The sail should be returned to a sail maker for a professional repair. Check for wear and tear, especially around the batten pockets, on a regular basis.



Roll from 2nd Batten.

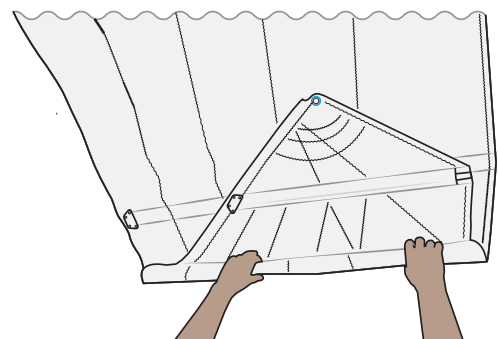



To complete this section, you will require:

- The jib
- The jib sheets

a)

The furling line emerges from under the beam through the cleat underneath the Port side.

Ensure that the furling unit is fully charged so that all the furling line is wound round the unit (turn anticlockwise) and very little left at the cleat.

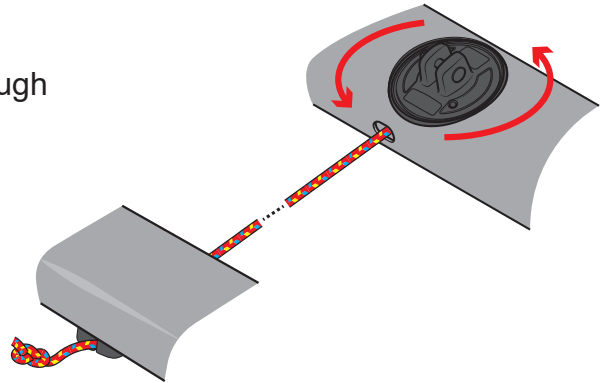

b)

Attach the head of the jib to the swivel using the clevis pin and ring. Ensure the swivel guide runs freely on the forestay.

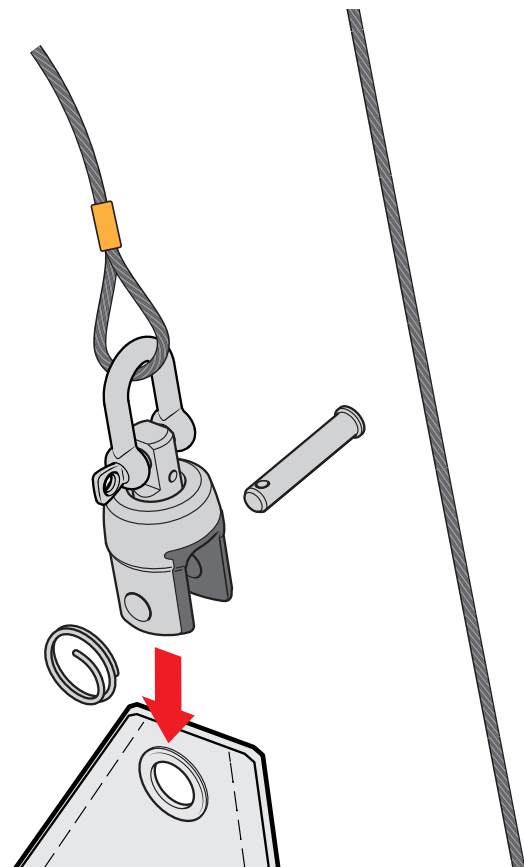
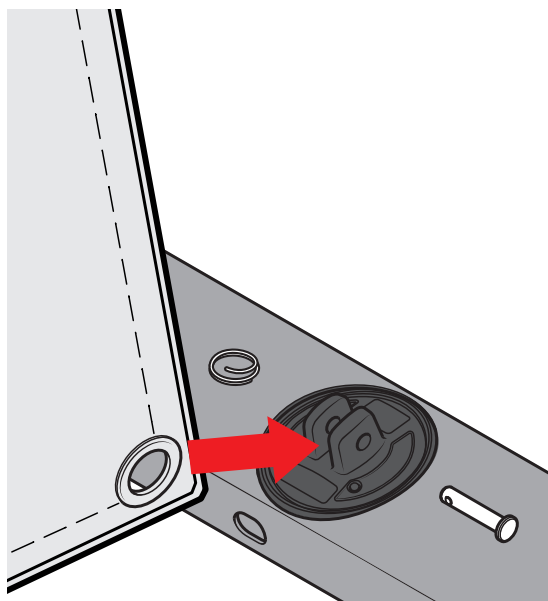

Attach the tack of the jib to the furler unit using the clevis pin and ring.

### Rig Tension - Purchase System

- c) Hoist the jib by pulling on the jib halyard. Hoist until the wire halyard appears.

Hook the rig tension cascade to the loop in the end of the wire halyard. It may help to obtain sufficient slack at this point if one crew member pulls firmly forward on the forestay.

Feed the tail of the cascade through the roller valley cleat on the side of the mast and through the turning block at the base of the mast.

Pull on some rig tension, a generous heave should be sufficient. Tidy the tail away in pocket on spinnaker bag



Ensure that the tensioning purchase is not twisted or fouling other systems (it should be the one closest to the mast).

Make sure the loop in the end of the halyard is not caught under the hook on the tensioning block.

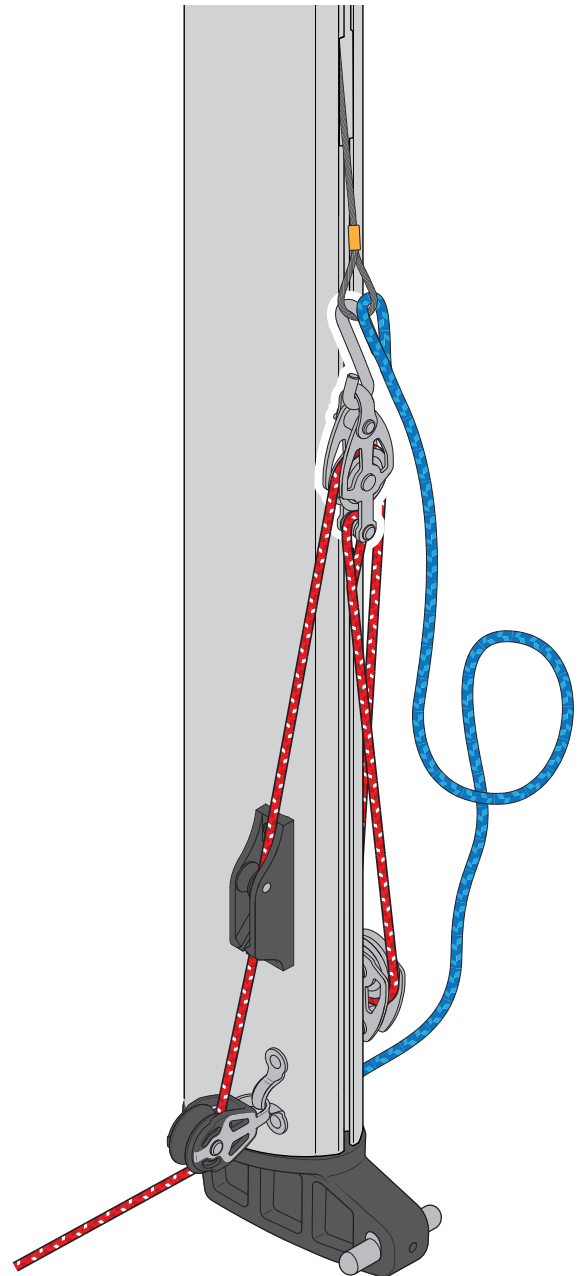

- d) Once the jib is hoisted, tensioned and cleated off. Untie the forestay from the tack bar.

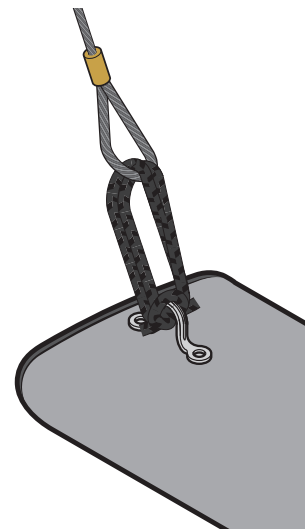

- d) Move the forestay back to the port side of the mast and in front of the mast beam. Using the bungee take up provided, tie off the end of the forestay and then tension the shock cord and tie off through the eye strap at the base of the mast.

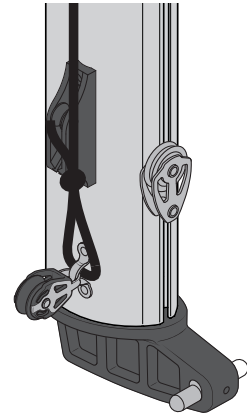

- d) Find the middle of the jib sheet, fold it back on itself, such that the two ends are together. Grab the folded mid point and pass it through the cringle in the jib clew, and then pass the two loose ends through that loop and pull tight. The result should look like this.

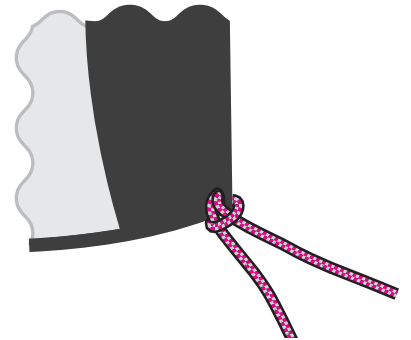

- e) Lead one end of the jib sheet along the side of the boat and then down to the jib fairlead and cleat. Thread it through the fairlead and through the jib cleat. Repeat with the other end of the jib sheet, making sure they pass either side of the mast. You can either tie a figure-of-eight knot in each sheet, or tie the two ends together. Preferably tie together.

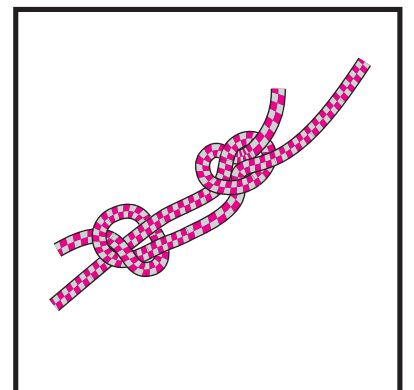
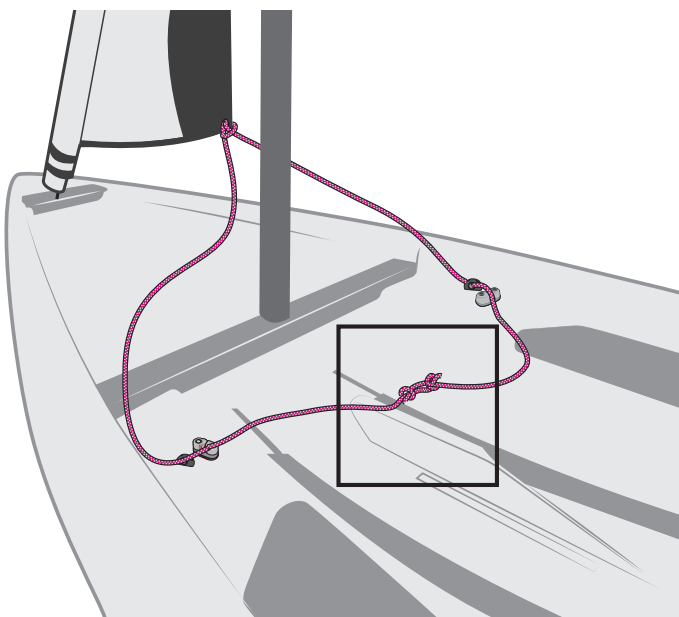

f)

Furling and unfurling the jib is best done from the front of the cockpit, or standing on the Port side of the boat adjacent to the shroud - in both cases with good access to the furling cleat.

To furl the jib, hold a little tension on the jib sheet and then firmly pull the furling line from the cleat. To unfurl, it is the reverse – pull the sheet and ease the furling line through the cleat.

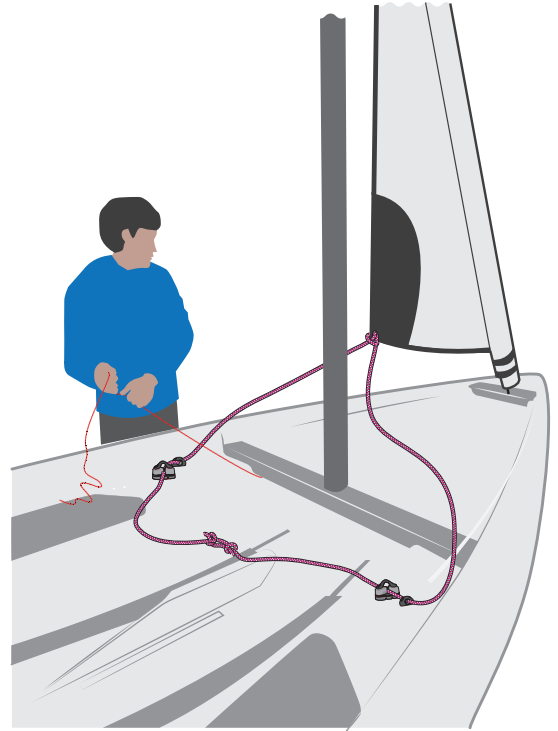

**NB. Furling the jib – take care the spinnaker halyard does not get caught at the top of the jib furler – pull it in towards the mast to keep it clear of the top of the jib.**

To hoist the mainsail:



Put the boat head to wind.

- a) Unroll the mainsail.
- b) Take the end of the main halyard that emerges from the top of the mast, and tie it to the head of the mainsail, by making a byte in the rope and passing it through the cringle and back over the head of the sail and then pass the bobble through the byte and pull tight.

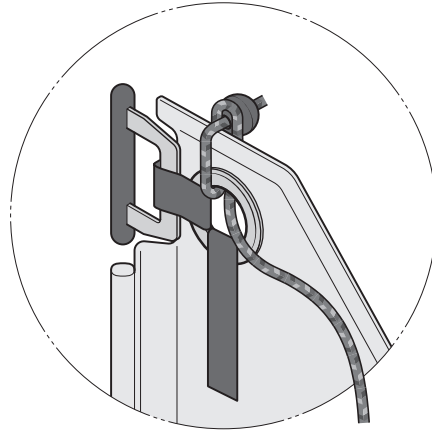
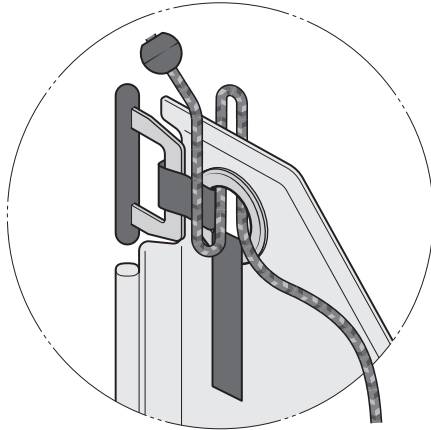

- c) Put the top of the main sail into the opening in the mast track, just above the gooseneck mast collar, from the starboard side of the boat.

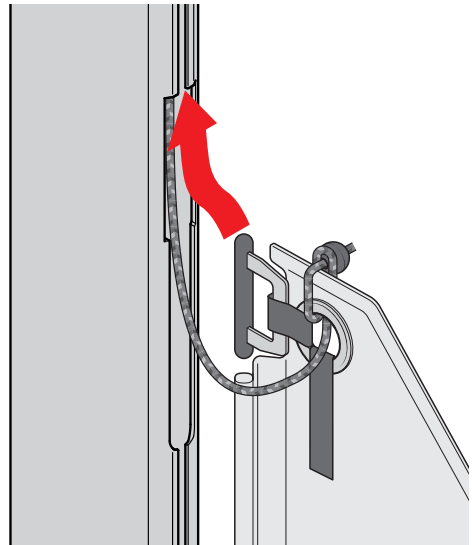

- d) When the main sail is almost at the top of the mast, slide the mainsail tack slug into the track on the mast.

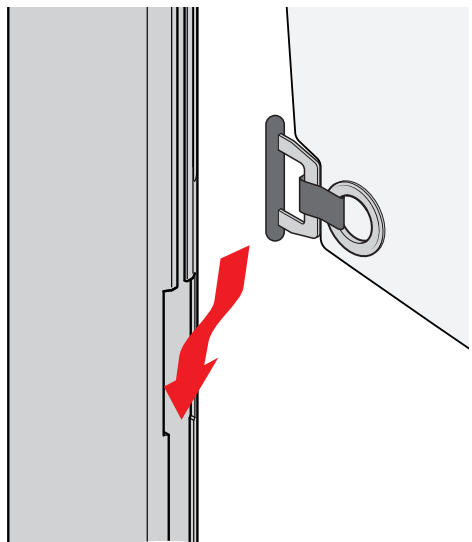

e)

Holding the main sail in line with the mast, pull on the end of the main halyard.

Pull the main sail up to the top of the mast. You will need to keep the sail in line with the mast to make pulling it up easier, especially when passing the batten pockets.

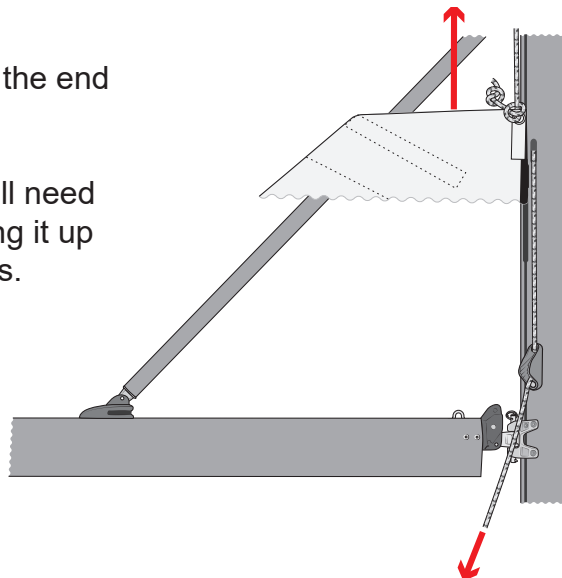

**If you are hoisting full sail ensure that the luff reefing slug, used for and adjacent to the reef point, stays OUT of the mast track.**

f)

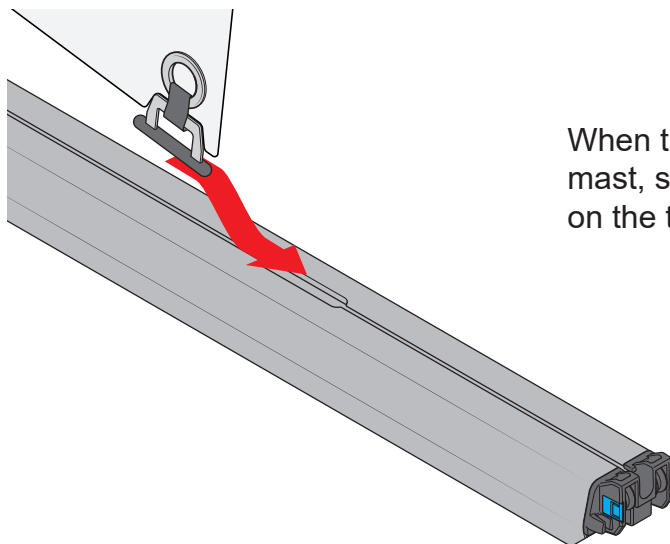

When the main sail is almost at the top of the mast, slide the mainsail clew slug into the track on the top of the boom.

g)

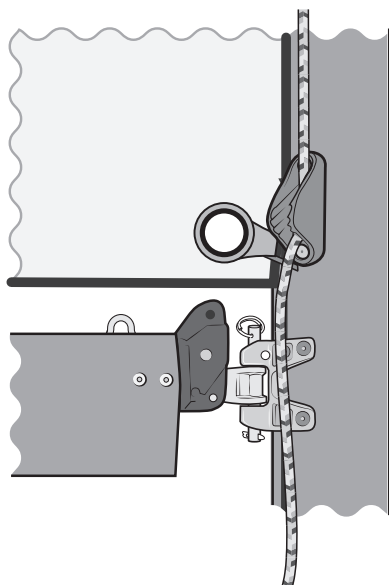

When the sail reaches the top of the mast, cleat off the main halyard in the cleat on the Starboard side of the mast.

**RS**  
**Tourea** 7.5 - Hoisting the Mainsail

g)

The main halyard tail can now be tidied away into the pouch on the sail. There are two pouches on the sail for the main halyard. Use the lower one unless the mainsail is reefed.

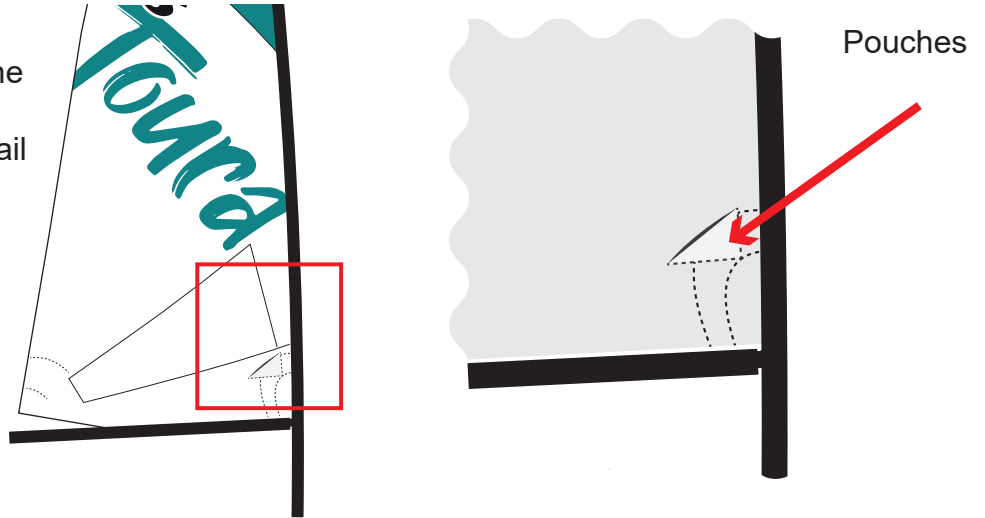

**RS**  
**Tourea** 7.6 - Outhaul

a)

Pass the end of the outhaul rope through the clew of the main sail and clip it on the end of the boom. Ensure that the main halyard rope is in the cleat and pull the main sail to the top. Pull on the main sail at the bottom corner near the mast to check that it is properly cleated.

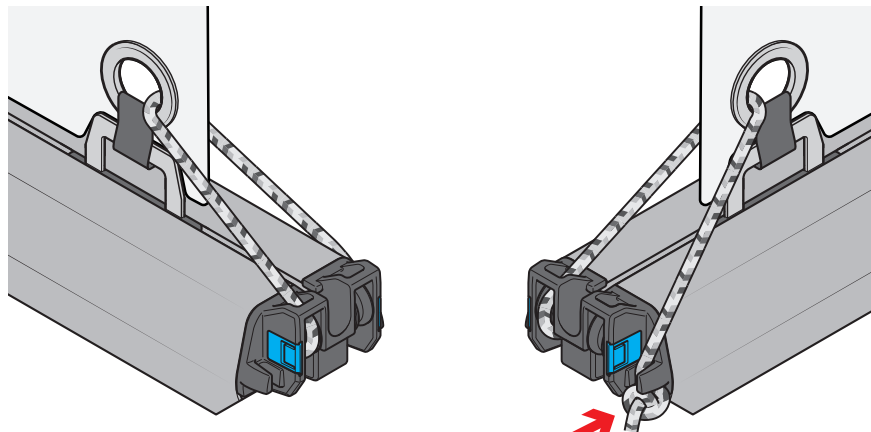
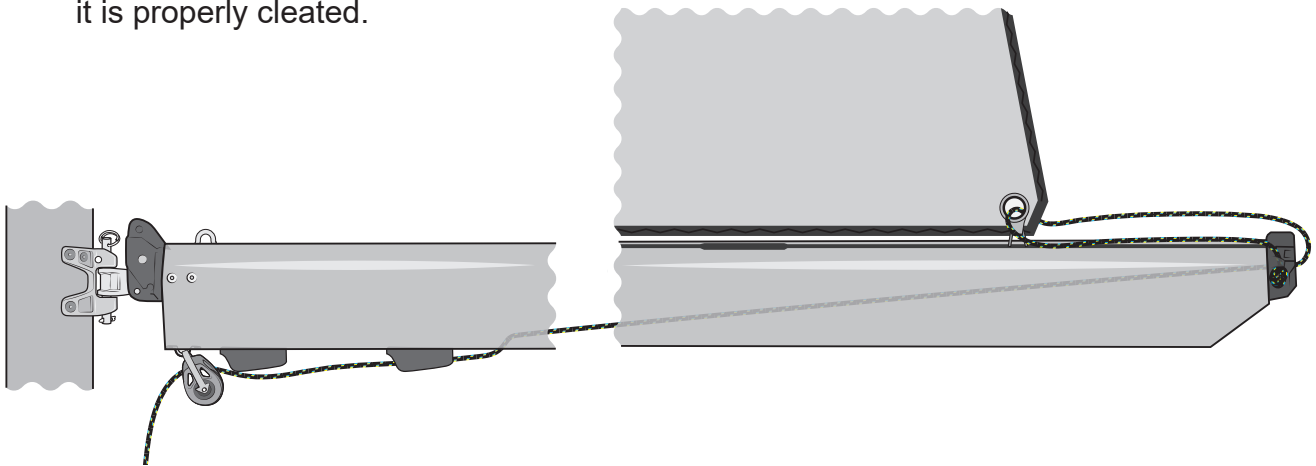

The knot at the end of the outhaul hooks into the cleat on the boom end.

a)

Tie an overhand knot in one end of 'Part 1' of the downhaul rope.

Thread the other end through the hole in the boom gooseneck joint.

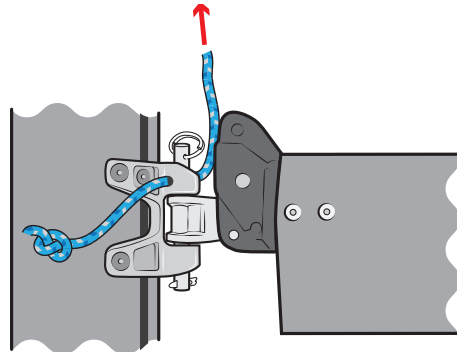

b)

Before proceeding make sure the lower sail slug is in the groove of the mast.

Pass 'Part 1' through the second cringle on the luff of the mainsail, tie on the 20mm block supplied. Now tie an overhand knot in the end of 'Part 2' of the downhaul. Pass the end through the becket on the cleat on the port side of the mast, then back up to the 20mm block and back down to the cleat.

Tie a figure-of-eight knot in the end.

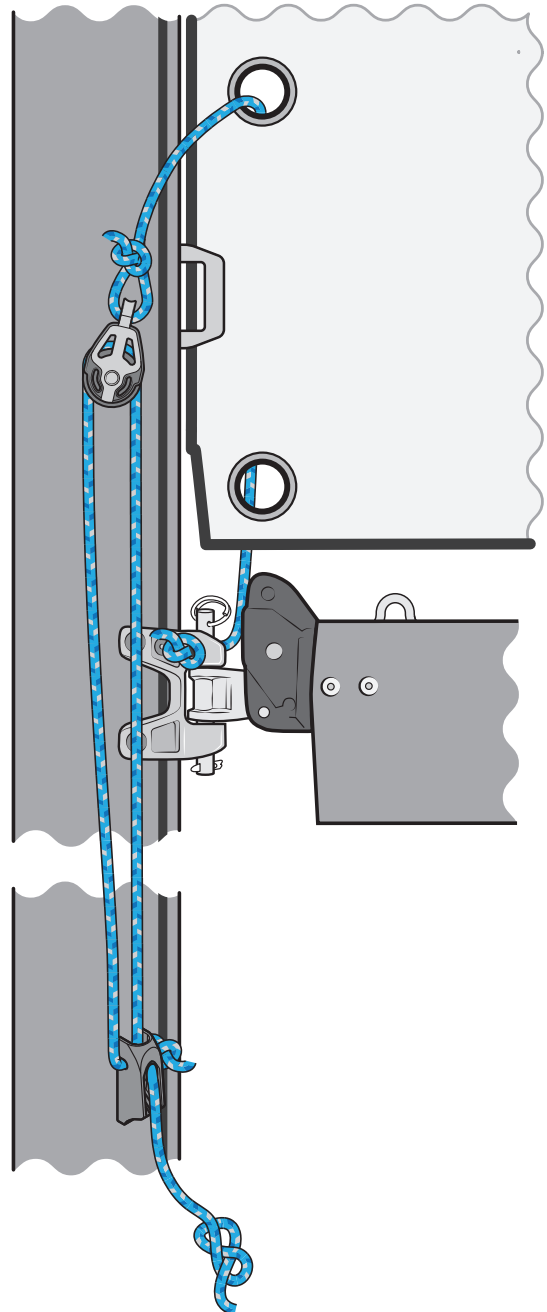
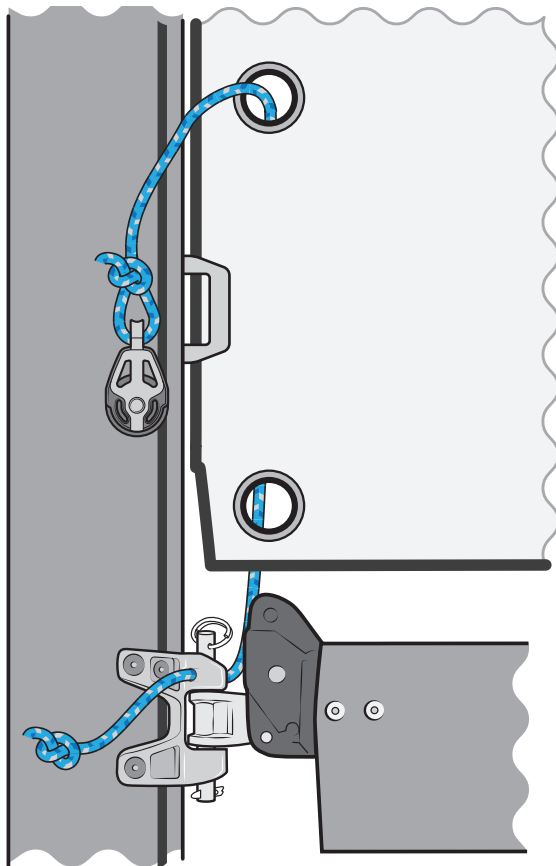



# **RS** Toura

## Rigging Guide

### 8 - Spinnaker



PLEASE FOLLOW RIGGING GUIDE IN CORRECT ORDER

**RS**  
Toura

a)

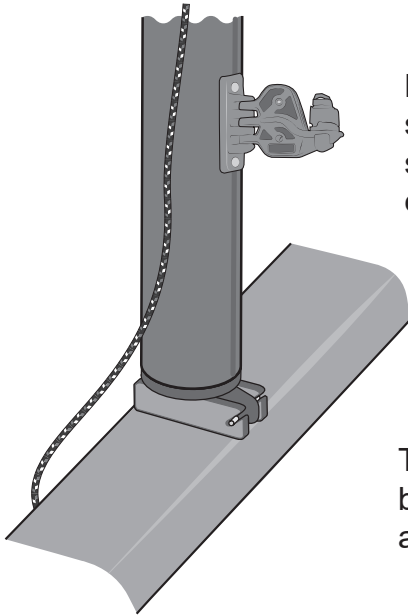

Before stepping the mast you should have attached the spinnaker halyard block to the mast and threaded the spinnaker halyard through it. You should now have two ends of the spinnaker halyard at deck level.

Take the end of the spinnaker halyard without the plastic bobble on it and feed it down the port side of the mast and down to the mast step.

b)

Pass the spinnaker halyard through the 30mm block to the port side of the bowsprit channel, and forward towards the bow (passing below the spinnaker sock).

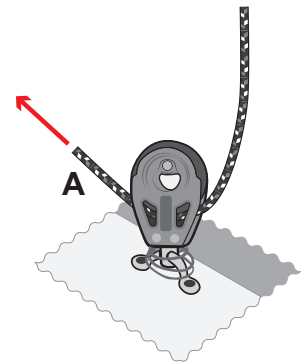
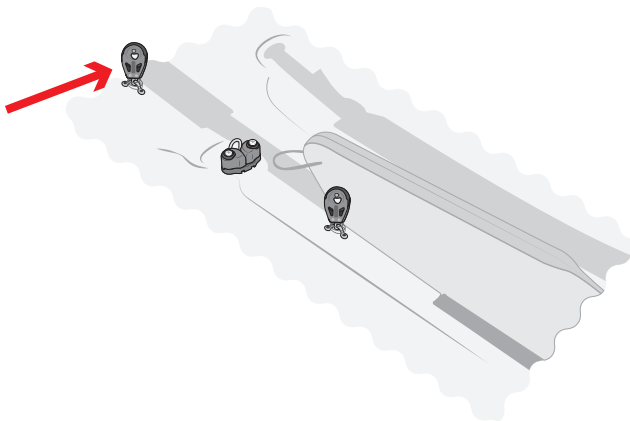

c)

Pass the end of the spinnaker halyard through the 30mm block at the bow as shown.

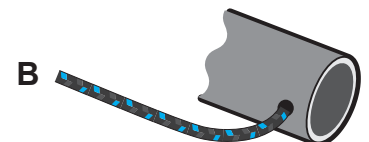
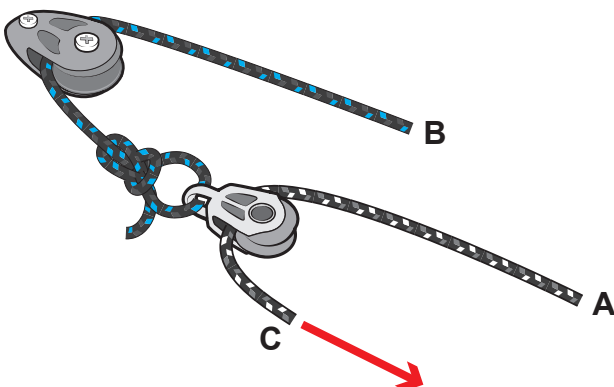

d)

Feed the end of the spinnaker halyard back towards the cockpit (again passing underneath the spinnaker sock). Pass it through the cleat and then the block just to the port side of the centreboard case.

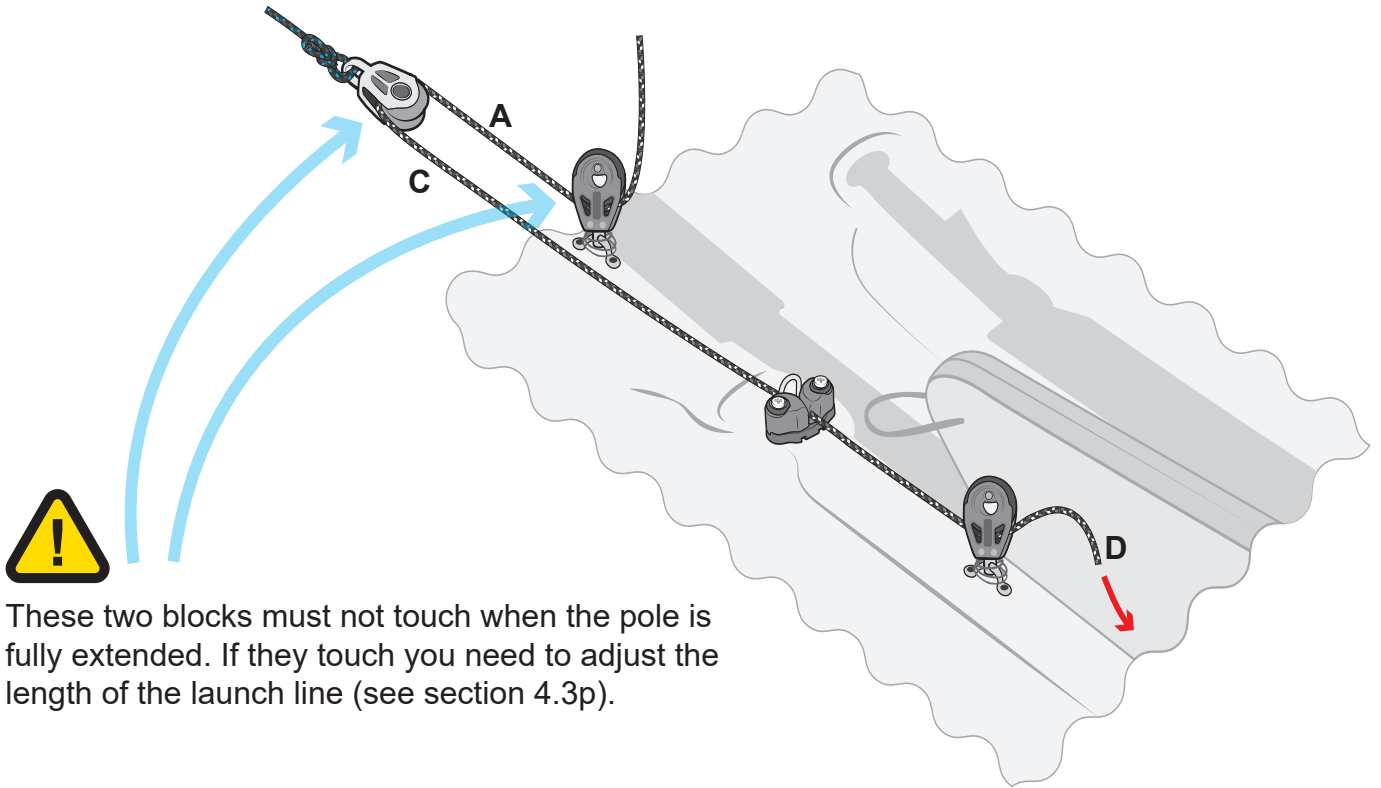

These two blocks must not touch when the pole is fully extended. If they touch you need to adjust the length of the launch line (see section 4.3p).

e)

Pass the spinnaker halyard through the block at the aft end of the spinnaker sock and then through the spinnaker sock towards the bow.

You may need to use the tiller extension as an aid to threading the halyard up the spinnaker sock.

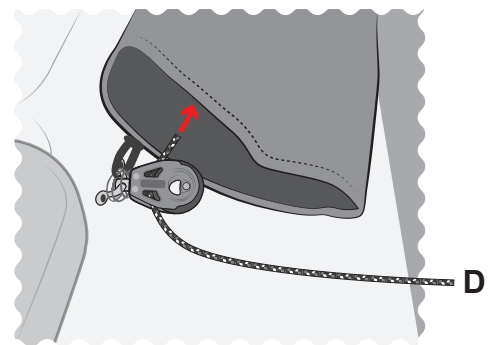

f)

Bring the tail of the spinnaker halyard out through the mouth of the spinnaker sock and pass it through the metal rings on the spinnaker before tying it to the rope eyelet on the back of the spinnaker with a bowline.

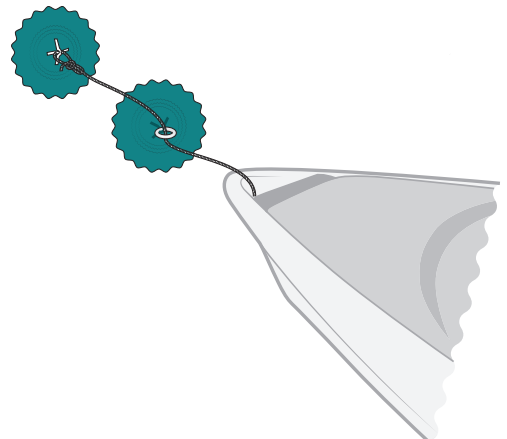

g)

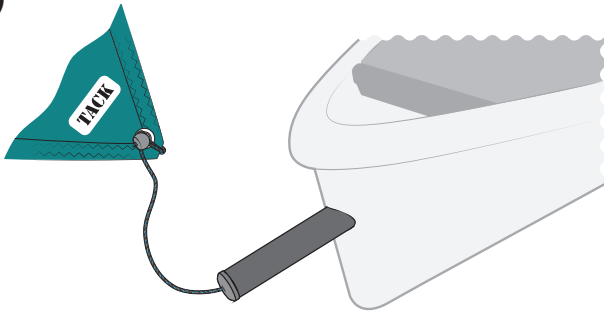

Attach the tack of the spinnaker to the line coming from the end of bowsprit.

h)

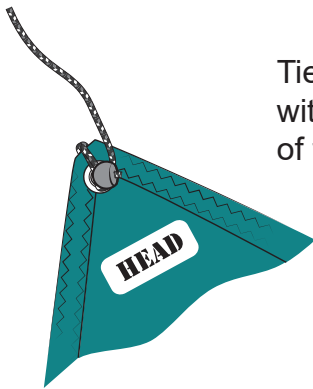

Tie the end of the spinnaker halyard with the plastic bobble on it to the head of the spinnaker.

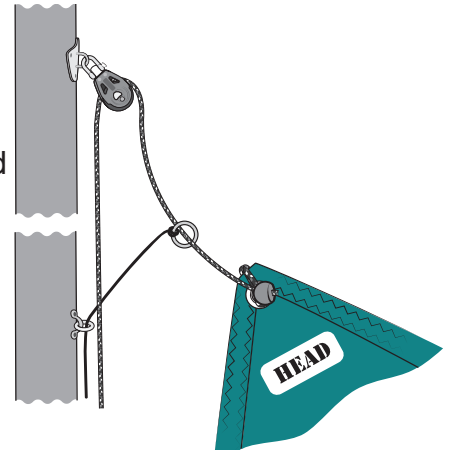

### Asymmetric Spinnaker System



Make sure these blocks do not touch when the pole is fully extended.

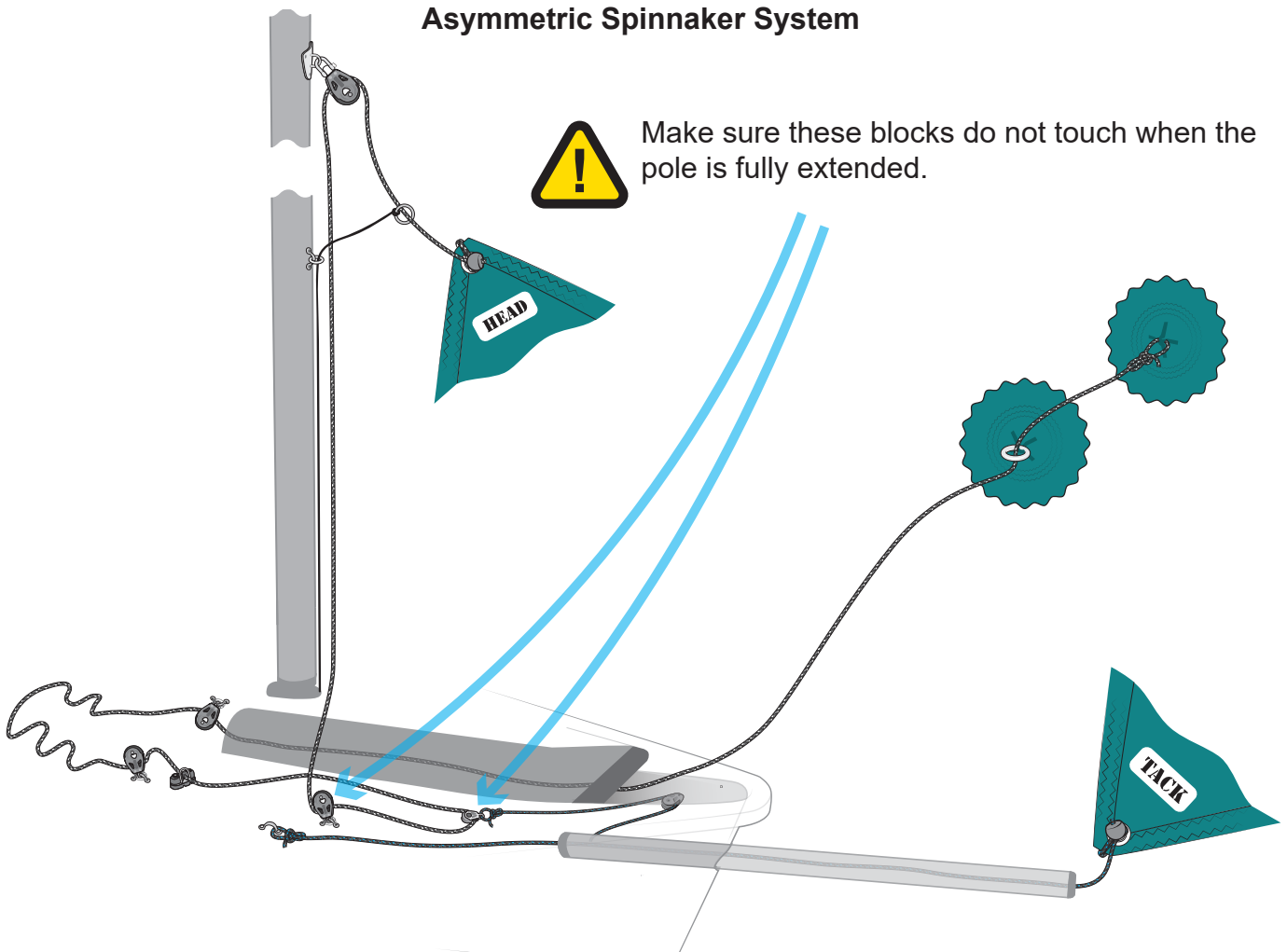

i)

Shackle the two ratchet blocks from the asymmetric spinnaker pack to the shroud eye bolts on either side of the boat. The shackle should be attached forward of where the shroud adjuster attaches.

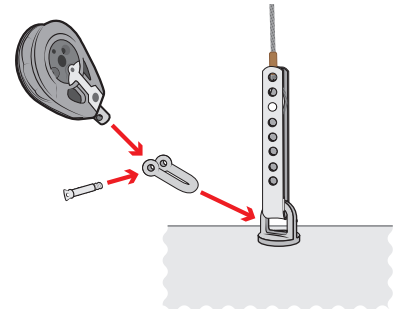

j) Find the middle of the spinnaker sheet and double it over to form a loop.

Pass this loop through the eyelet at the clew of the spinnaker.

Pass the rest of the sheet through the loop and pull it tight. This is the same arrangement as the jib sheet, so you will have done it before.

k)

With the spinnaker on the port side, thread one end of the spinnaker sheet through the block by the port shroud adjuster plate, in the direction of the arrow on the block .

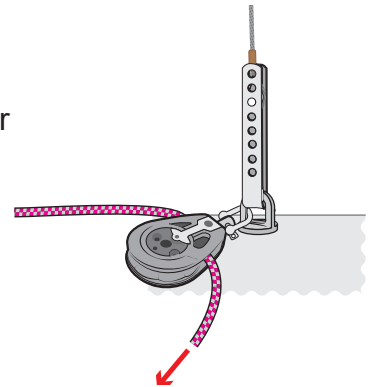

l)

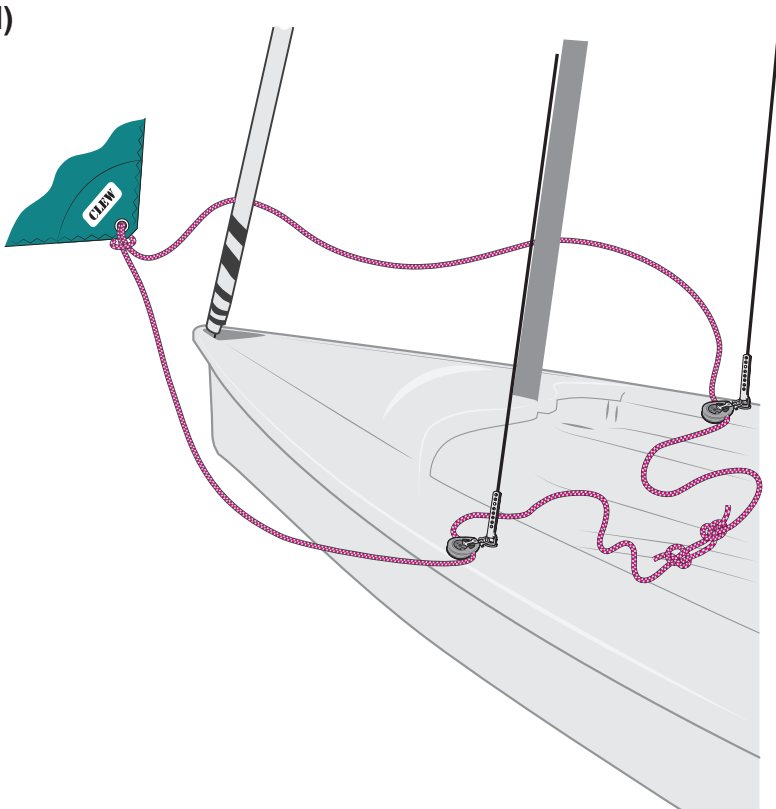

Lead the other spinnaker sheet around the Jib luff and through the block on the starboard side. Tie the two ends of the spinnaker sheet together.

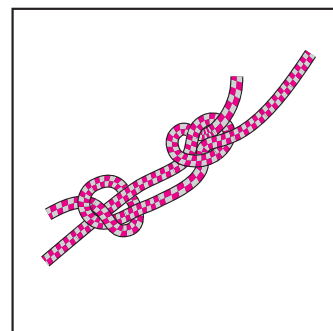

# **RS** Toura

## Rigging Guide

### 9 - Foils

To complete this section you will need:

- The rudder pack
- A large flat-bladed screw driver



PLEASE FOLLOW RIGGING GUIDE IN CORRECT ORDER

# Toura

a)

In the rudder pack you will find the rudder, tiller, tiller extension and two small flathead screws.

Insert the tiller into the stock. Line up the holes, **making sure that the tiller extension joint is on the top of the tiller**, Then attach using the screws provided.

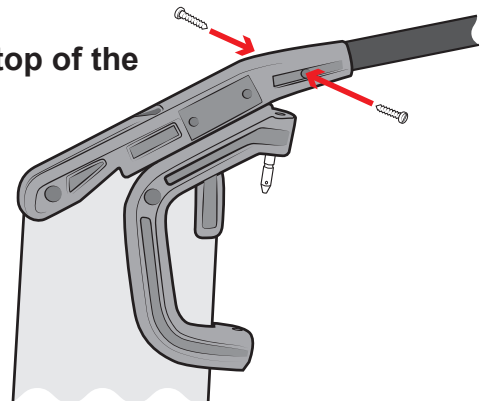
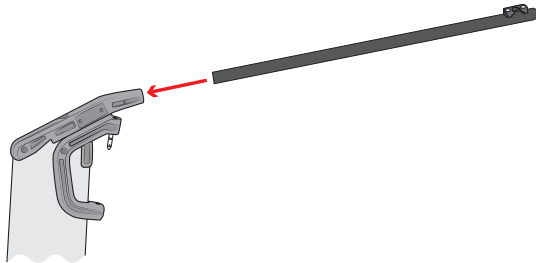

b)

Attach the tiller extension.

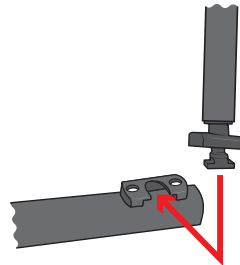

LOCKING GUDGEON  
- PUSH TO RELEASE

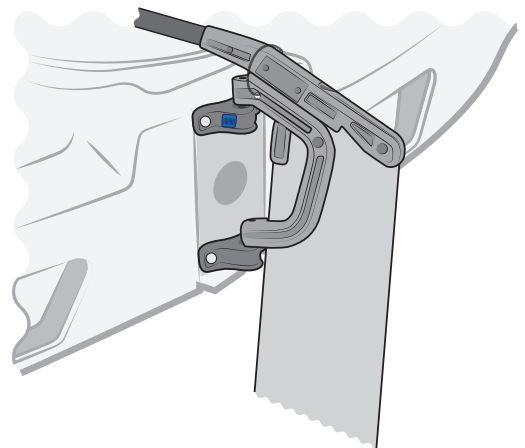
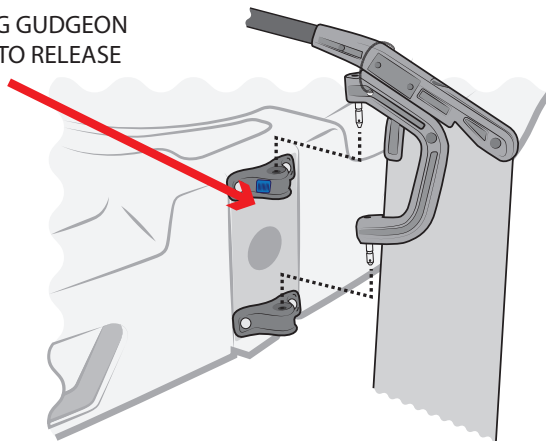

### To put the rudder down -

1. Lift the tiller slightly to unlock the blade.
2. Push the tiller aft until the blade is fully lowered (it will normally 'clunk' into the front of the rudder stock).
3. Push the tiller firmly down to 'lock' the blade.

To pull the rudder up -

1. Lift the tiller slightly to unlock the blade.
2. Pull towards you (into the boat) until the blade reaches it's maximum up position.
3. Push the tiller gently down to hook over the top of the stock.



Do not paddle with the rudder half up.

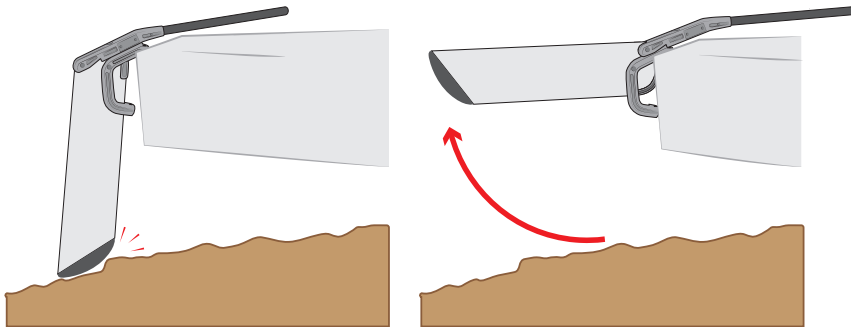

As a safety feature the rudder will unlock and come up if it hits the bottom.

a)

The centreboard retainer is a rope with a plastic hook which attaches to a red bungy on the opposite side of the centreboard case.

Un-clip the centreboard retainer.

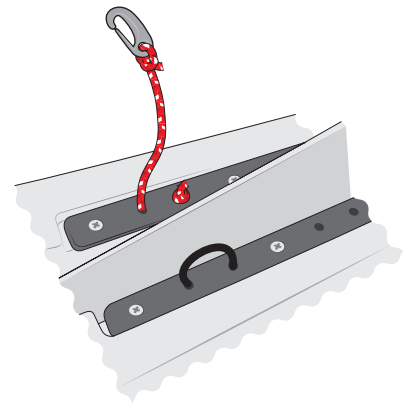

b) When you are in deep enough water, rotate the centreboard into position.

c) Attach the retainer in front of the board and below the plastic bobbles.

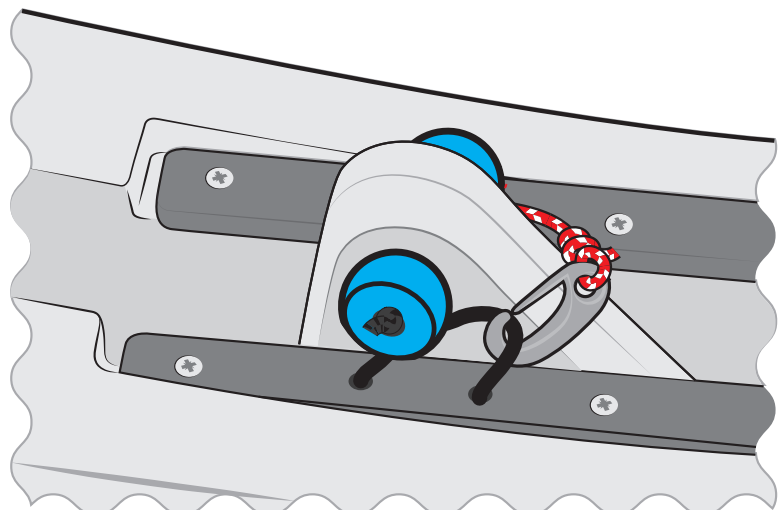



# **RS** Toura

## Rigging Guide

### 10 - Reefing



PLEASE FOLLOW RIGGING GUIDE IN CORRECT ORDER

# **RS** Toura

## 10.1 - Rigging your reefing line.

Reefing enables the less-experienced or younger sailor to continue sailing in stronger winds. Your RSToura is fitted with a single-line reefing system. The reefing line is black and red and is installed in the boom ready to rig through the sail. You will see it either end of the boom, next to the outhaul line, which is usually blue. At the front end of the boom the reefing and outhaul lines share the same block, as they do not need to be pulled on at the same time.

Please follow the instructions for reefing, ensuring that the reefing line is threaded the correct way through the mainsail. One person may reef the mainsail while sailing on a gentle close reach, sails eased, on a starboard tack.

Ideally put in the reef before launching. It is possible with care to complete on the water. Make sure you are in plenty of clear water while reefing.

a)

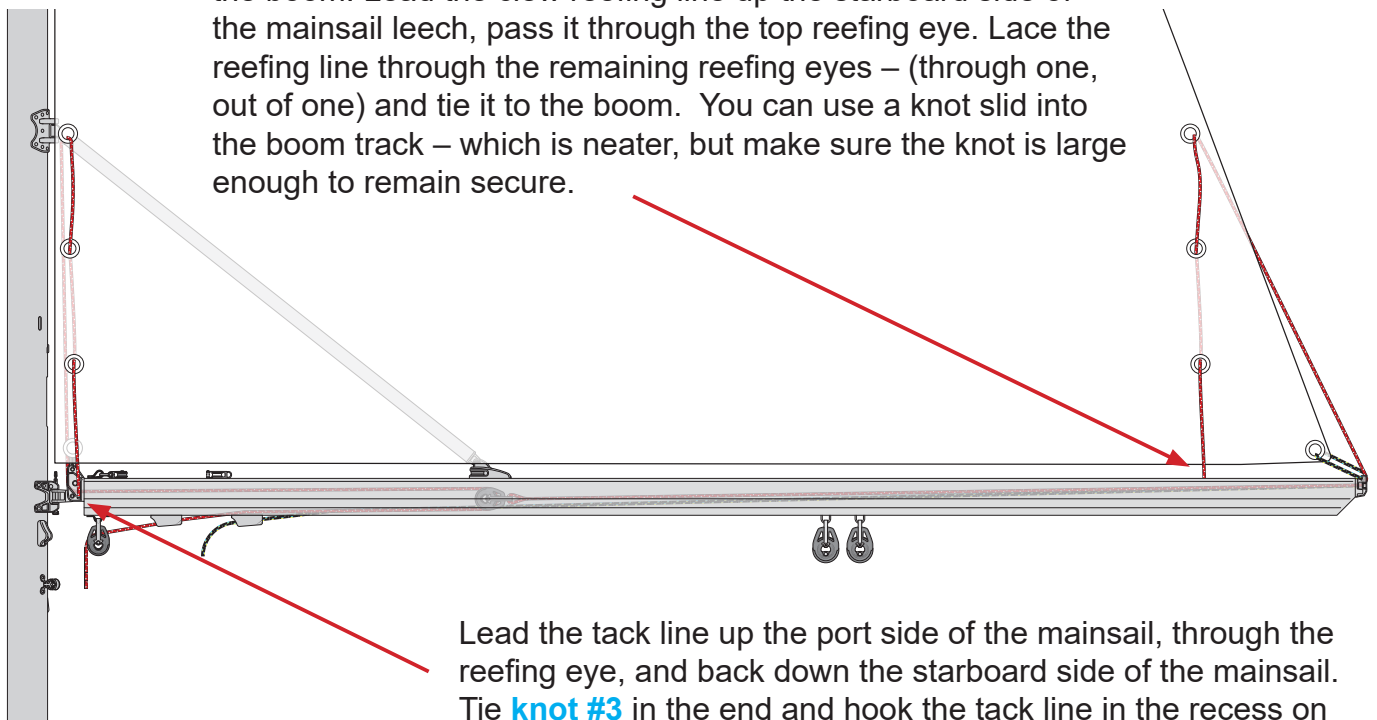

Ease the reefing line right out from the outboard (clew) end of the boom. Lead the clew reefing line up the starboard side of the mainsail leech, pass it through the top reefing eye. Lace the reefing line through the remaining reefing eyes – (through one, out of one) and tie it to the boom. You can use a knot slid into the boom track – which is neater, but make sure the knot is large enough to remain secure.

Lead the tack line up the port side of the mainsail, through the reefing eye, and back down the starboard side of the mainsail. Tie **knot #3** in the end and hook the tack line in the recess on the port side of the gooseneck.

## 10.2 - Reefing the Mainsail

a)

With the mainsheet uncleated, fully ease the kicker whilst steadily pulling the reefing line from the front end of the boom. This, as you can see from the picture will start to concertina the sail at the aft end first.

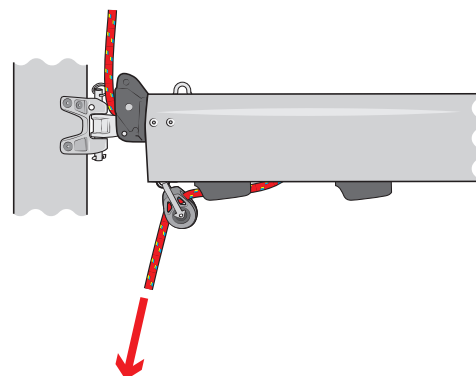

b)

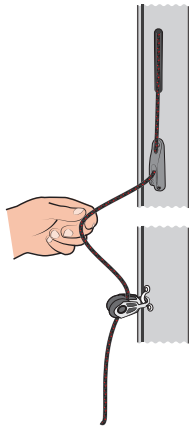

When the clew has fully tightened, ease the main halyard whilst continuing to pull the reefing line.

The luff will fold down.

c)

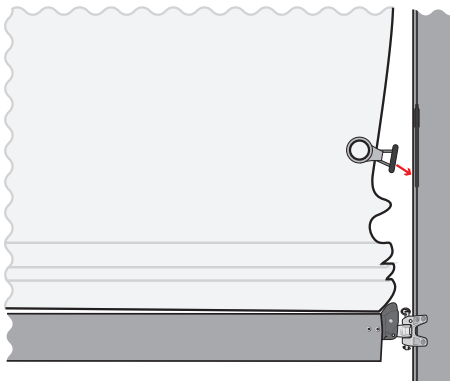

Make sure the reefing clew slug is inserted into the track on the mast. Then hook the cringle on the sail through the hook on the top of the boom

d)

Re-cleat the main halyard, when the reefing position is lowered down to the boom. Tie a sail tie through the cringle in the middle of the sail and around the boom with a reef knot. Now fully tension the halyard again to get sufficient tension in the luff of the mainsail.

e)

Finally re-tension the kicker for some control of the leech.

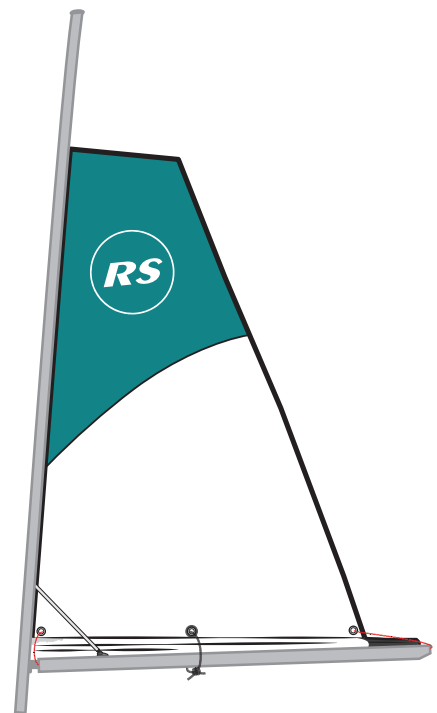

**HINT**

The jib is a very effective strong wind sail area because it is low down and maintains a balanced helm. So slab reef before you lose the jib – it's more fun for the crew!

# RS Toura

## Rigging Guide

### 11 - Trapeze Kit

#### Contents:

- 2 x trapeze wires and adjuster
- 1 x elastic takeup
- 1 x lowers
- 2 x shackles
- 2 x length of rope



**MAXIMUM TRAPEZE WEIGHT 80kg**



The chance of entrapment is increased with the use of trapeze equipment. The lowers, trapeze rings and harness hooks all contribute to the change in risk. Please ensure the crew, safety equipment and any additional support is suitable for the environment before venturing afloat.



RS

Toura

a) Attach the two trapeze wires to the mast.

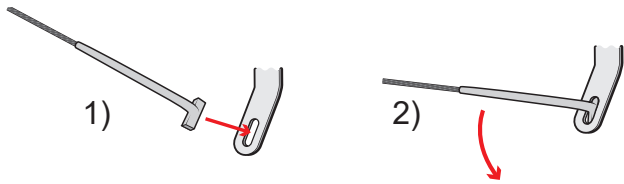

NOTE use the upper tangs

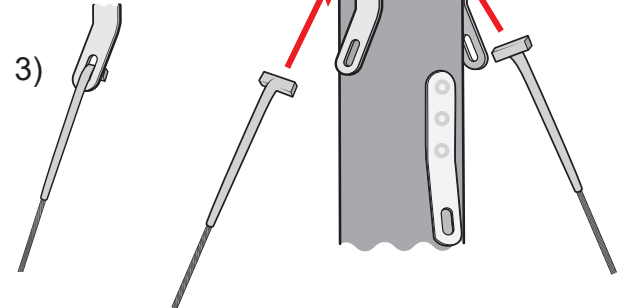

b) Continue to rig and step the mast **as described in section 6 of the RS Toura rigging manual.**

c) Take the trapeze elastic and tie a bowline in one end.

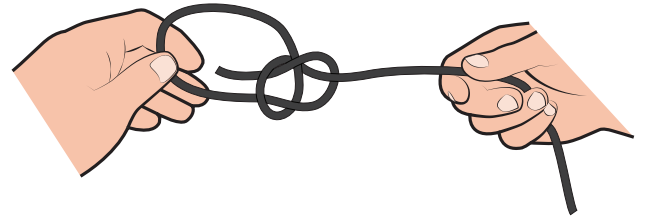

d) Feed the other end through the port shroud eye bolt (from outside towards the middle of the boat).

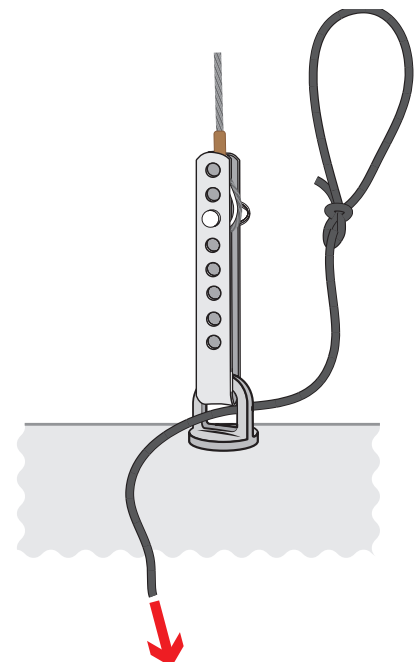

e)

Pass the end through the plastic toestraps retainer clips as shown.

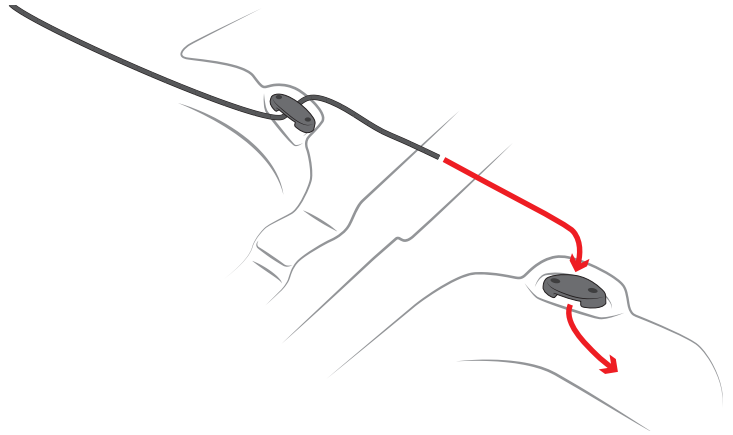

f)

Feed the end through the starboard shroud eye bolt (away from the centre of the boat) and tie a bowline in the end.

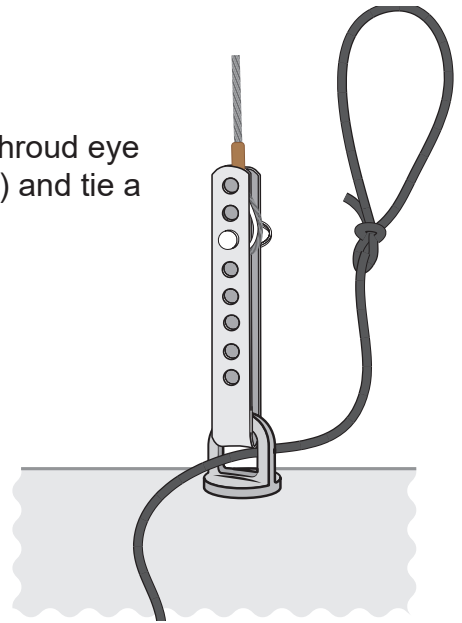
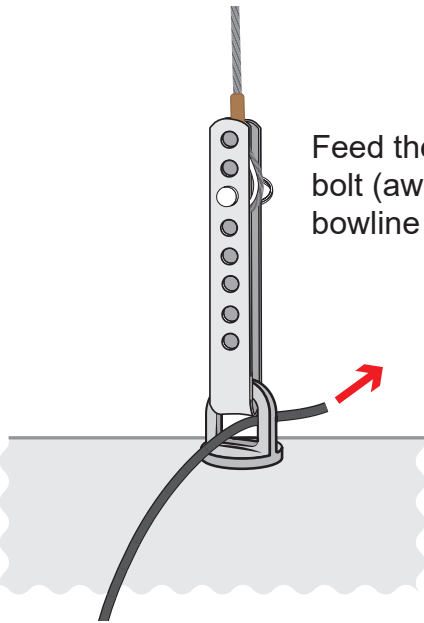

g)

Connect the trapeze wires to the elastic.

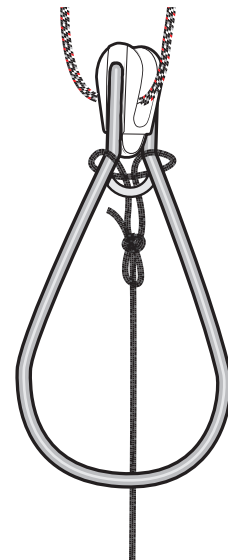
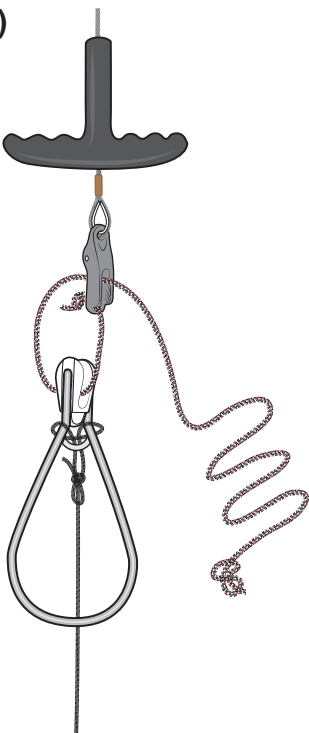

h)



**VERY IMPORTANT**

**Adding the lowers**

Shackle the lowers onto the eye strap on the front of the mast

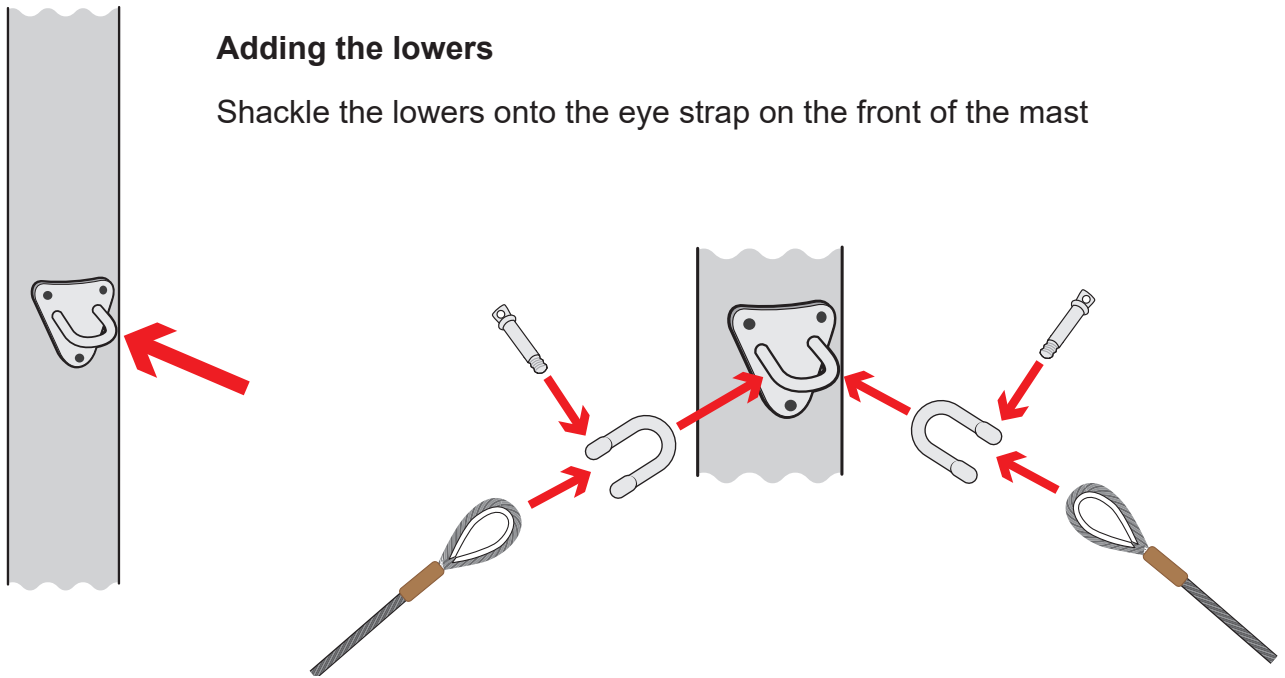

i)

Lash the lowers tightly onto the shroud eye bolts using the lengths of rope provided.

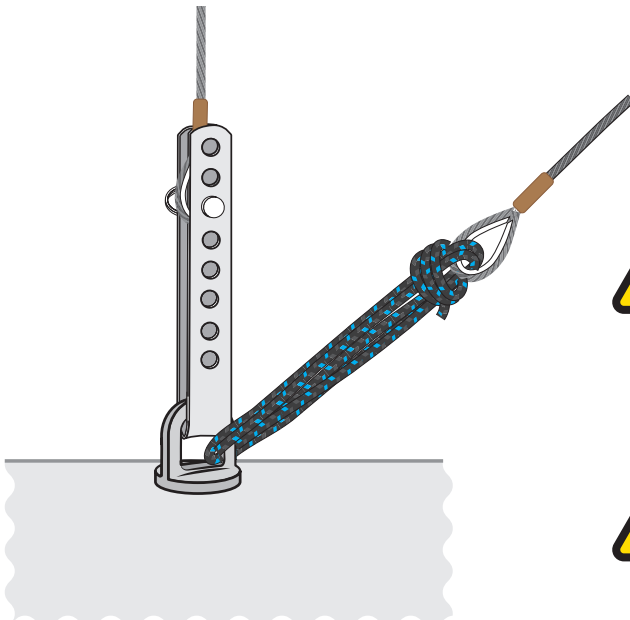

Make sure that even weight is added to the lowers.



Lowers must be tightened after the rig is tensioned.



**MAXIMUM TRAPEZE WEIGHT 80kg**



# **RS** Toura

## Rigging Guide

### 12 - Outboard bracket



PLEASE FOLLOW RIGGING GUIDE IN CORRECT ORDER





The optional outboard bracket pack contains:

Outboard bracket

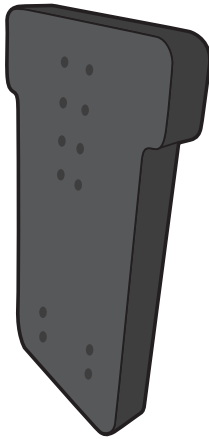

Pintle



Bolts, nuts and washers x 4



Eye bolts x 2



- a) First bolt the pintle to the outboard bracket through the second and third row of holes as shown.

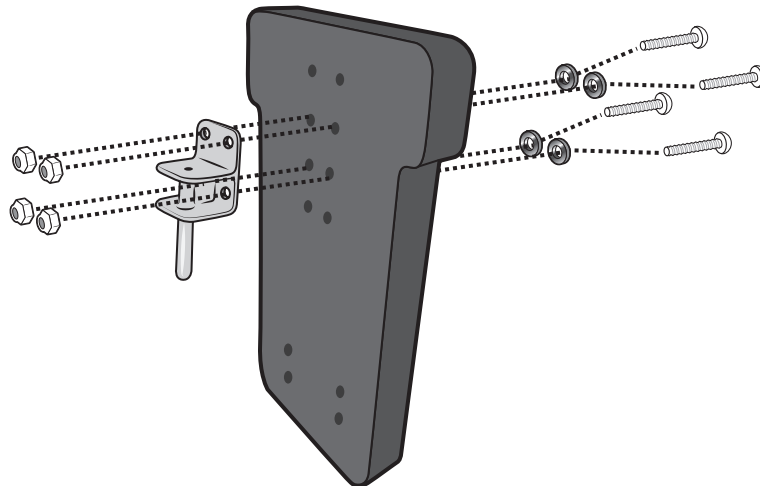

The outboard bracket is universal and can be set up in different ways for different RS boats, so it is important that you assemble it correctly or it will not fit the Toura.

- b) Fit the outboard bracket to the boat by dropping the pintle into the hole on the top of the transom on the starboard side.

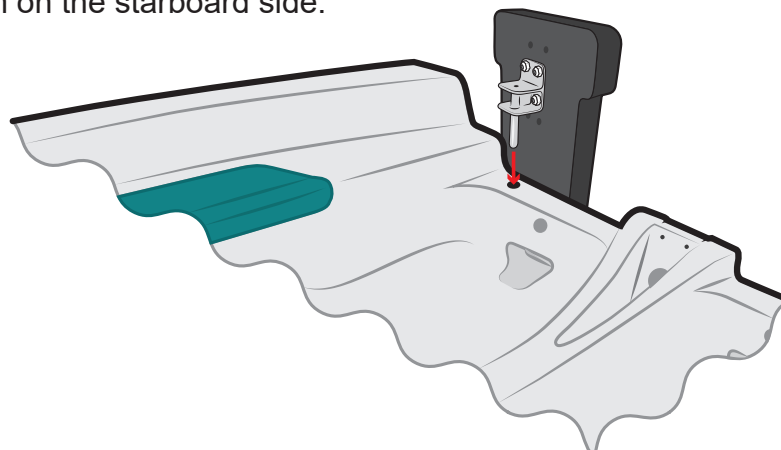

c) If you have assembled the bracket correctly, the bottom two holes on the outboard bracket should now line up with two threaded inserts on the aft face of the transom.

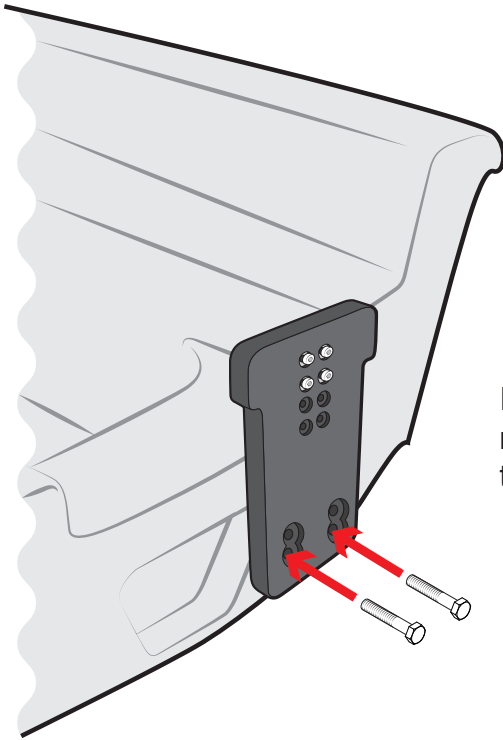

Insert the two bolts and tighten using 13mm socket and ratchet. You are now ready to attach an outboard motor to the Toura.

# **RS** Toura

## Rigging Guide

### 13 - Sailing Hints



PLEASE FOLLOW RIGGING GUIDE IN CORRECT ORDER

# **RS** Toura

### 13.1 Introduction

The RS Tourea is a very rewarding boat to sail – to fully appreciate its handling, you should be comfortable with the basic techniques of sailing small boats. If you lack confidence or feel that a refresher is in order, there are many approved sailing schools which can be recommended. See [www.rya.org.uk](http://www.rya.org.uk) for more information.

While we offer you a few hints to aid your enjoyment of your new boat, they should not be considered as a substitute for an approved course in dinghy sailing. In order to build your confidence and familiarise yourself with your new boat, we recommend that you choose a fairly quiet day with a steady wind for your first outing.

### 13.2 Launching

With the sails fully hoisted, and the rudder attached, the boat should be wheeled into the water, keeping it head to wind as far as possible. If you have a crew, s/he can hold the boat head to wind whilst the trolley is stowed ashore.

#### TOP TIP

If the tide is coming in as you launch, make sure that you leave the trolley far enough up the beach that it will not be swept away.

### 13.3 Leaving the Beach

The easiest way to get going is for the helm to step aboard while the crew holds the boat. The helm should put a little centreboard down, then move back to his normal position and lower some of the rudder blade. Then, s/he may instruct the crew to push the bow off the wind and climb in. The crew will then lower the centreboard as depth allows. As soon as the water is deep enough, the centreboard should be fully lowered, and the retaining elastic clipped to the rope handle to prevent it retracting into the hull in the event of a full inversion.

#### TOP TIP

If you are using the jib, pulling this sail in as you leave the beach will ensure that the bow continues to swing away from the direction that the wind is blowing from.

As soon the water is deep enough, make sure that you lower the rudder blade fully. You will know it is fully down if you feel a gentle “thud” as the front face of the blade hits the front face of the stock. Push the tiller down to lock the blade. Pull the sail in and you are away! For the best performance, you should ensure that you and your crew position yourselves so that the boat is sailing through the water as upright as possible.

#### TOP TIP

As a general rule, sit further forward in lighter winds and further aft in stronger breezes.

### 13.4 - Sailing Close-Hauled and Tacking

When sailing close-hauled, or as close as possible to the wind, it is important to get the boom as near as possible to the centreline, especially when sailing the with the mainsail and jib. The kicking strap should be firmly tensioned for upwind work.

The jib sheet should be pulled in fairly hard when sailing upwind – tighter in stronger winds and less so in lighter winds. Sail to the jib tell-tails, keeping the one on the back of the sail streaming and the one closest to you either streaming or lifting upwards slightly.

To tack, push the tiller extension away from you and, as the boat starts to turn, step across the cockpit facing forwards. Once the boat has completed the turn, bring the tiller back into the centre before sitting down on the new side, with the tiller extension behind your back. When you are settled, swap the mainsheet and the tiller extension into the new hands.

If the boat slows right down and feels lifeless when close-hauled, you could be sailing too close to the wind. Ease the mainsheet and 'bear off' ie. turn away from the wind for a while to get the boat going again.

### 13.5 - Sailing Downwind and Gybing

When sailing downwind, both sails should be let out as far as possible. To gybe, pull the tiller towards you and, as the boat starts to turn, step across the cockpit facing forward. Once the boat has completed the turn, bring the tiller back into the centre before sitting down on the new side, with the tiller extension behind your back. Often, the boom will not want to come across until you have nearly completed the gybe, so it often pays to give the mainsheet a tweak to encourage the boom over at the moment that you want it to come! Don't forget to duck your head as the boom comes over. Once you are settled, swap the mainsheet and the tiller extension into the new hands.

### 13.6 - Using the Spinnaker

If you are inexperienced in using a spinnaker, choose a fairly quiet day for your first excursion. A spinnaker nearly doubles your sail area, and should be treated with a healthy degree of respect!

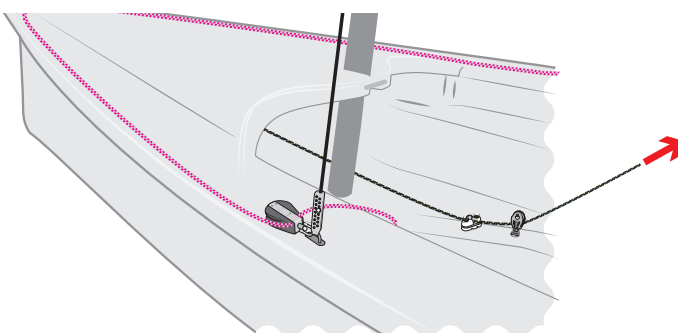

For your first hoist you should be sailing downwind on a broad reach, with the wind coming over the helm's aft shoulder. The crew should sit in the centre of the boat, astride the centreboard case, and hoist the spinnaker by pulling the spinnaker halyard from the port side of the centreboard.

The spinnaker halyard pulls the bowsprit out at the same time – when the spinnaker is hoisted, you are ready to go. The crew, or the helm if sailing singlehanded, should now pull gently on the leeward spinnaker sheet until the spinnaker has filled. Spinnakers may be effectively used from a close reach to a broad reach so, to get downwind, one should become adept at gybing. It is not possible to tack with the spinnaker hoisted. For the best effect, the spinnaker sheet should always be eased as far as possible, so that the luff is just on the point of curling.

Gybing with the spinnaker is fairly straightforward. Like the jib, it should be pulled across at the same time as the mainsail comes across. As soon as it has been pulled in and filled with wind, it should again be immediately eased for maximum efficiency and speed

To drop the spinnaker, reverse the procedure used to hoist. The boat should be sailing on a broad reach, and the slack in the spinnaker downhaul is pulled in from the left hand halyard block. As the spinnaker downhaul goes tight, the spinnaker halyard should be popped out of the cleat. Then, pull the remainder of the spinnaker downhaul through until the spinnaker is pulled sharply into the chute. Dropping the spinnaker on tighter reaches is harder, and requires more effort on the spinnaker downhaul.

#### TOP TIP

Tie a rope bobble onto the spinnaker halyard, about 10 cm from the bowline that is attached to the head of the spinnaker. This will make dropping the spinnaker easier.

#### HINT

The spinnaker can “bunch up” when entering the chute. This can be minimised by keeping some tension on the spinnaker sheet, preventing the clew from being sucked into the chute with the main body of the spinnaker.

When the spinnaker is fully lowered, tidy the sheets and the halyard to keep the cockpit area clear.

## Bowline

The bowline is a reliable knot used for tying a loop in rope. It is extremely strong when under load, and unties easily once free of load. Some people use the rhyme “the rabbit comes out of the hole, round the tree, and back down the hole” as a way of remembering how to tie a bowline.

Take the end of the piece of rope and assess how big a loop you require

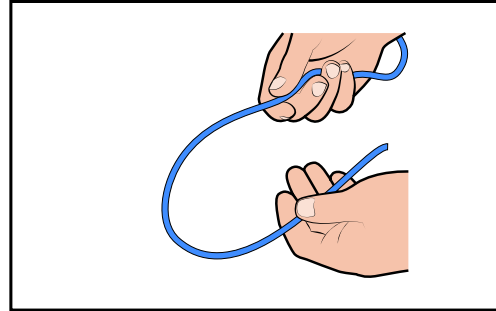

Make a small loop in the rope

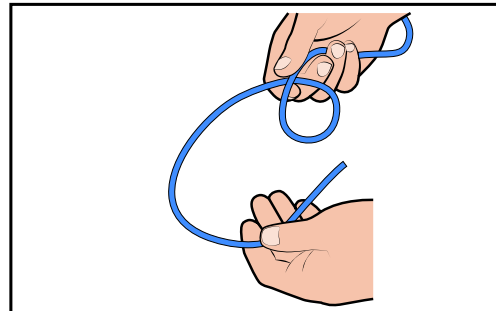

Take the tail and lead it up through the loop

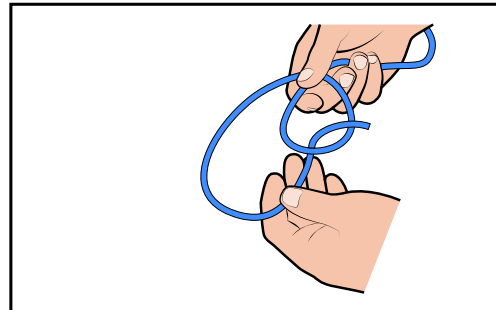

Pass the tail around the standing rope

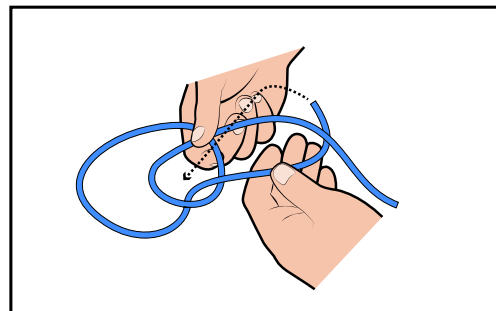

Thread the tail back through the loop, and tighten

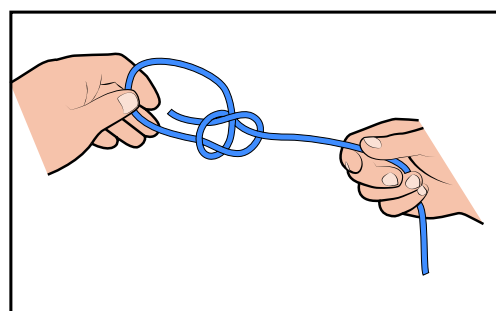

## Knot-on-knot

A 'knot-on-knot' is useful for tying the end of a rope to a sail or a fitting, and is particularly reliable due to the manner in which the rope binds upon itself.

Tie a single overhand knot in the end of the rope. Feed the rope through the sail or the fitting, and tie another overhand knot in the rope.

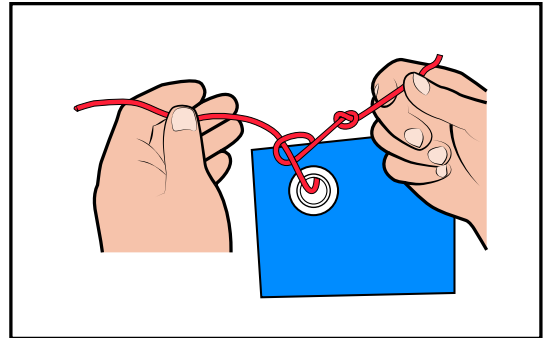

Pull the rope tight so that the rope binds on the original overhand knot.

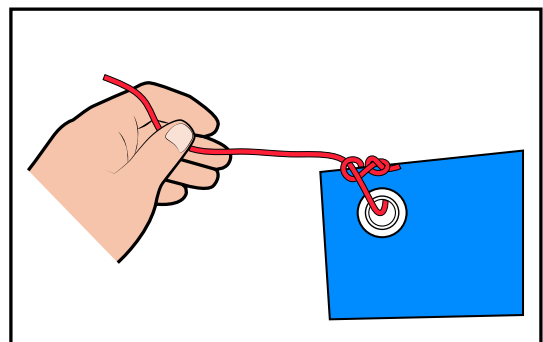

## Figure-of-Eight

The 'figure-of-eight' knot is used as a stopper knot, preventing ropes from slipping through fittings. Like the bowline, the 'figure-of-eight' knot unties easily once free of load.

Make a loop in the end of the rope

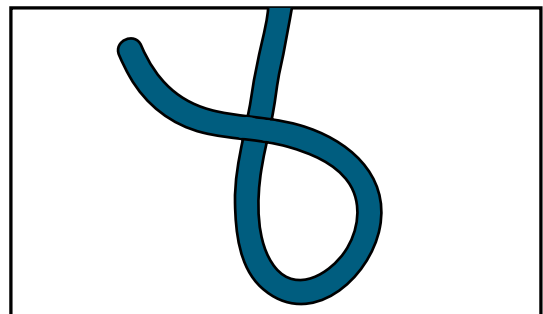

Lead the tail underneath the standing end of the rope

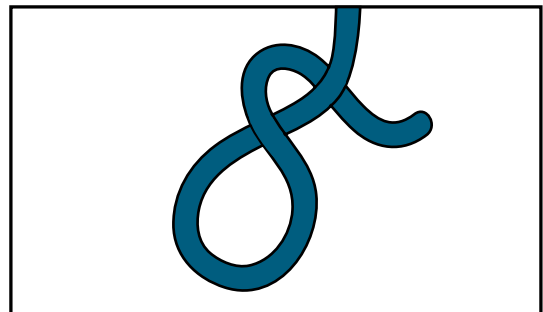

Lead the tail of the rope back through the loop, and tighten

