

C420 Parts Guide

1. [Spinnaker Camcleat H365 - 20039](#)
2. Spinnaker Camcleat Screw (2) – **Flat 10-32 x 1 ¾ in**
3. [Spinnaker 29mm Single Fixed Block H348 - 20040](#)
4. [Dyneema - 3mm, 18inches](#)
5. C420 Non-Skid Set, Long (3in X 60in) - **20063**
6. Jib Fairlead - **20005**
7. Jib Fairlead Screw (2) – **Pan 10-32 x 1 ½ in**
8. [Jib Camcleat H365 - 20039](#)
9. [Jib Camcleat Wedge - 20038](#)
10. Jib Cleat Screw (2) – **10-32 x 1 ¾ in**
11. Spinnaker Guy Clamcleat - **20010**
12. Spin Guy Clamcleat Wedge - **20011**
13. Spin Guy Clamcleat Screw (2) – **Flat 10-32 x 1 ½ in**
14. Shroud Eyestay, Forged - **20055**
15. Shroud Eyestay Screw (2) – **Pan ¼-20 x 1 ½ in**
16. Ronstan Small Fairlead – **20006**
- 16b. Fairlead Screw (2) – **Pan 6-32 x ¾ in**
17. Ronstan Large Fairlead - **20005**
18. Fairlead Screw – **Pan 10-32 x 1 ½ in**
19. [Mast Step - 20026](#)
- 19b. Selden Mast Step (Not Pictured) - **44009**
20. Mast Step Screw (3) – **Flat 10-32 x ¾ in**
21. Mast Step Bolt (Not Pictured) (2) – **Pan ¼-20 x 1 ¼ in**
22. Mast Step Nut (Not Pictured) - ¼-20 Jam Nyloc
23. [Mast Retainer Clam Cleat - 20042](#)
24. Clam Cleat Screw

Deck Fittings

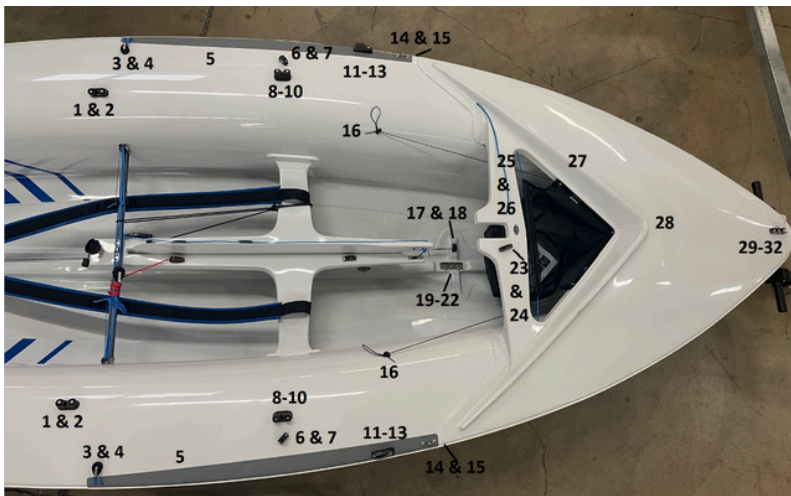
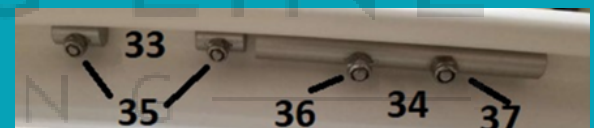
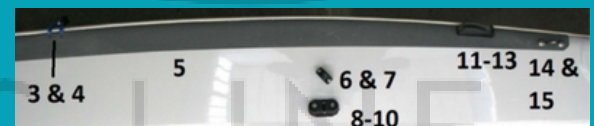

Traveler Bar

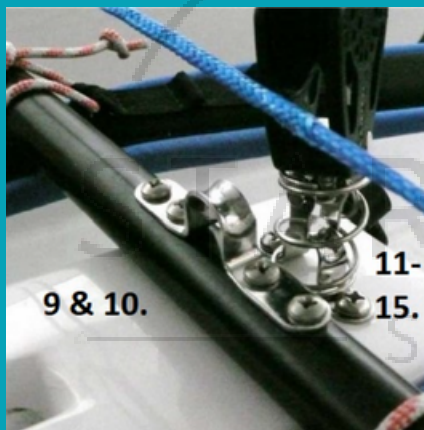

1. [Traveler Bar, Complete - 20037](#)
2. Traveler Bar End Mount - 20434
3. Traveler Bar End Mount Screw (2) - Pan 10-32 x 3/4 in
4. Bridle and Bar Mount Bolt - 1/4-20 x 1 3/8 in
- 4b. Bridle and Bar Mount Nut - 1/4-20 Lock Nut
- 4c. Bridle Bolt Bushing - 20074
5. [Spinnaker Halyard Cleat - 20046](#)
6. Spin Halyard Cleat Screw (2) - Pan 8-32 x 1 1/4 in
- 6b. Spin Halyard Cleat Washer (2) - 10 x 7/16
- 6c. Spin Halyard Cleat Nut (2) - 8-32 nyloc
7. Spin Halyard Bushing - 20012
8. Spin Halyard Bushing Screw (2) - Pan 6-32 x 3/4 in
- 8b. Spin Halyard Bushing Washer (2) - 10 x 7/16
- 8c. Spin Halyard Bushing Nut (2) - 6-32 Nyloc
9. 4-Hole Eyestraps - 20044
10. 4-Hole Eyestraps Screw (4) - Pan 10-32 x 2in
- 10b. 4-Hole Eyestraps Washer (4) - 10 x 7/16
- 10c. 4-Hole Eyestraps Nut (2) - 10-32 Nyloc
11. [2-Hole Eyestraps - 20034](#)
12. 2-Hole Eyestraps Screw (2) - Pan 1/4-20 x 1in
- 12b. 2-Hole Eyestraps Nut (2) - 10-32 Nyloc
13. [Stand-up Block Shackle - 20020](#)
14. [Stand-up Spring - 20045](#)
15. [57mm Harken Mainsheet Block - 10015](#)



Centerboard Trunk

1. Harken Through-Deck Block - **20029**
2. Through-Deck Block Screw (2) – **3/16 x 1/2in**
- 2b. Through-Deck Block Washer - **10 x 7/16**
3. [C420 Centerboard Pivot Bolt Assembly - 20271](#)
4. [C420 Hiking Strap Plate - 20015](#)
5. Hiking Strap Plate Screw (2) – **Pan 10-32 x 3/4 in**
- 5b. Hiking Strap Plate Nut (2) - **10-32 Nyloc**
6. [Clamcleat CL211MK2 – 20042](#)
 1. Clamcleat Screw (2) – **Flat 8-32 x 3/4 in**
- 7b. Clamcleat Washer (2) - **10 x 7/16**
- 7c. Clamcleat Nut (2) - **8-32 Nyloc**
8. Clamcleat Line Keeper – **20087**
9. Line keeper screw
10. [C420 Hiking Strap - 20016](#)
11. Anderson Super Shute SS60 Bailer – **24007**
- 11b. Older Models: Super Mini Bailer - **20007**
- 11c. [Other Builders: Super Medium Bailer - 20174](#)
12. C420 Vang Lead Block (20mm) – **20370**
13. Lead Block Screw
14. Centerboard – [20102 \(white\)](#), **20207**

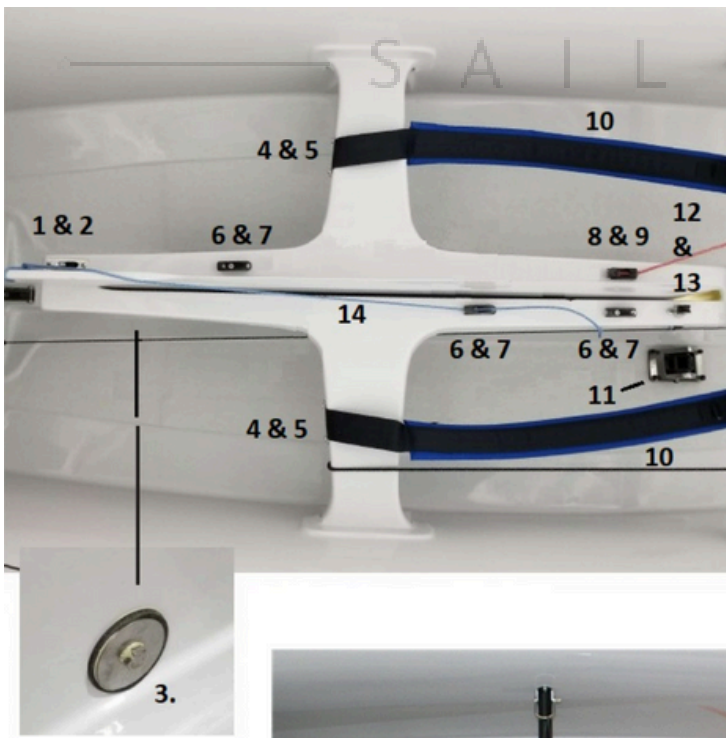

Centerboard Gasket

1. [Gasket Retainer - 20018](#)
2. Polyester Gasket - 20210
- 2b. [Sailcloth Gasket - 20354](#)
3. Gasket Retainer Screws (22) – Flat #8 x 3/4 in



1. [Upper Pintle - 20032](#), LP Boats use [20270](#)
2. Upper Pintle Screws (2) – 1/4 -20 x 1 1/2 in
- 2b. Upper Pintle Washer (2) - 1/4 x 5/8
- 2c. Upper Pintle Nut (2) - 1/4-20 Nyloc
3. [Rudder Clip - 20297](#)
4. Rudder Clip Screws (2) – Pan 10-32 x 5/8 in
- 4b. Rudder Clip Washer (2) - 10 x 7/16
- 4c. Rudder Clip Nut (2) - 10-32 Nyloc
5. [Lower Pintle - 20031](#), LP Boats use [20269](#)
6. Lower Pintle Screws (2) – Pan 1/4 -20 x 1 in
- 6b. Lower Pintle Nut (2) - 1/4-20 Nyloc
7. [Drain Plug - 20098](#)
8. Drain Plug Screw (2) – Pan #6 x 1/2 in
9. [Eyestraps - 20034](#)
- 9b. Eyestrapscrew (2) – Pan 1/4 -20 x 1in
10. [Eyestraps Nut \(2\) - 10-32 Nyloc](#)



Stern & Transom



Rudder & Tiller

Rudder, Complete (White) - 20166

Rudder, Complete (Gray) - 20231

Rudder Head, Complete - 20075

1. Rudder Side Plate - 20072

2. Rudder Shim (Not Pictured) - 20124

3. Rudder Blade, White - 20076

3b. Rudder Blade, Gray (Not Pictured) - 20206

4. Rudder Pivot Bolt - 20169

5. Shockcord Hook (6mm) - 80200

6. Red Shock Block - 24101

7. Rudder Head Gudgeon - 20073

8. Gudgeon Bushing - 30004

9. Rudder Head Bolt - $\frac{1}{4}$ -20 x 3/8 in

10. Rudder Head Lock Nut - $\frac{1}{4}$ -20

11. Rudder Spacer - 20074

12. Rudder Bushing - 30006

Tiller with Extension, 33in - 20344

Tiller with Extension, 36 in - 20121

13. Tiller Extension Only, 33in - 20077

14. Tiller Extension Only, 36in - 20097

15. Universal Tiller Joint - 20185

16. Tiller Joint Wedge - 80306

17. Aluminum Tiller Only - 20120

18. Micro Clam Cleat - 20109

19. Tiller Wedge - 80306

20. Tiller End Cap - 80307



Dwyer Boom

Boom, Unrigged – **20004**

Boom, Complete - 20114

1. Gooseneck Assembly - 20371

2. Outhaul Cheek Block 29mm – 20289

2b. Cheek Block Rivet

3. Mainsheet Boom Bail – **20215**

3b. Mainsheet Boom Bail Rivet

4. Mainsheet Boom Block, 40mm 90° - 20115

5. Vang Bail – 20214

5b. Vang Bail Rivet

6. Small Clam Cleat, CL211MK2 - 20186

6b. Clam Cleat Rivet

7. Boom Eyestraps - 20218

7b. Eyestraps Rivet

8. 29mm Block - 20040

9. U Bracket - 20139

10. Split Ring - 20035

11. Universal Gooseneck - 20140

12. Gooseneck Clevis Pin - 20254

13. Gooseneck Bracket - 20265

14. Gooseneck Mast Rivet

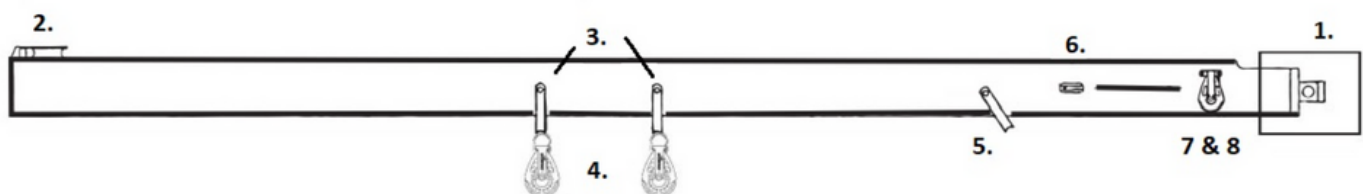
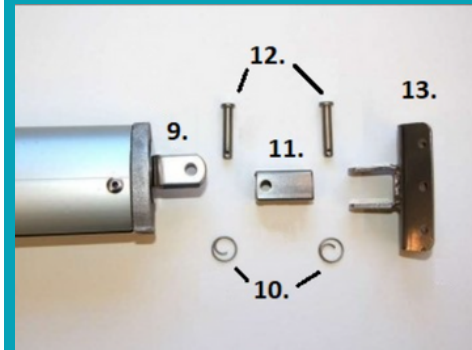

Selden Boom



Boom, Complete - **20318**

1. [Outhaul Cheek Block - 20219](#)
2. Outhaul Eyestraps
- 2b. Outhaul Eyestraps Rivet (2)
3. Outhaul Cheek Block Screw
4. [Mainsheet Block, 40mm - 43531](#)
5. Selden Eyestraps (3) - **20442**
- 5b. Eyestraps Screw (6)
6. Selden Eyestraps Clamp (6) - **20443**
7. [Outhaul Clam Cleat, CL211MK2 - 20186](#)
8. Clam Cleat Screw
9. Outhaul Block, 30mm - **43553**
10. Outhaul Block Eyestraps
11. Eyestraps Screw (2)
12. Gooseneck - **20250** or **20334**
13. Spigot Assembly - **20438**
14. Spigot - **20230**
15. Spigot Pin - **20273**

STARTING LINE
SAILING

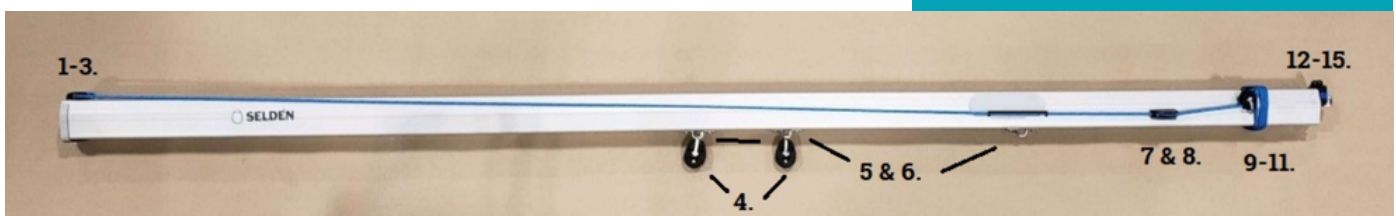

Mast

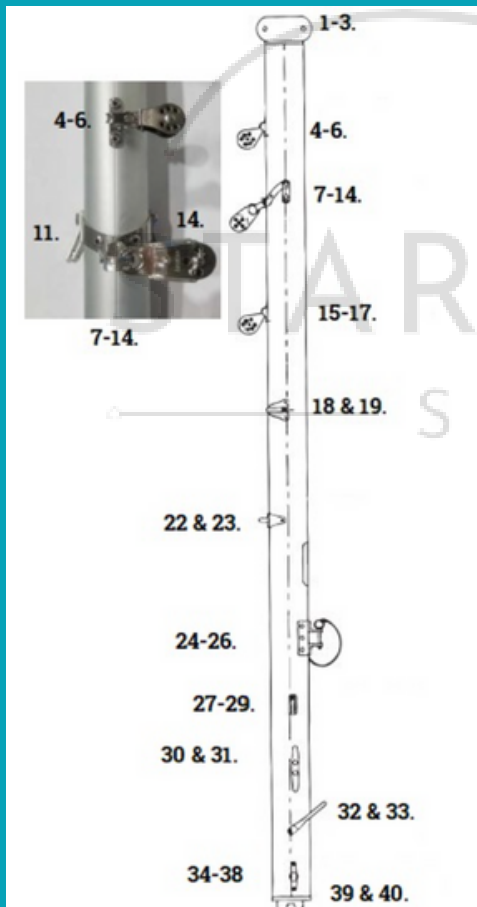

1. [Masthead Casting – 20126](#)
2. [Masthead Sheave \(2\) – 20262](#)
3. [Masthead Clevis Pin \(2\) – 20253](#)
4. [Eyestraps – 20218](#)
5. Eyestrapscrew (2)
6. [Block, 22mm Limited Swivel – 20059](#)
7. [Hounds Assembly – 20128](#)
8. Hounds Assembly Screw
9. Hounds Shackle – 20056
10. [Hounds Bracket – 20257](#)
11. Tang (2) – 20130
12. Hounds Assembly Bolt
13. Hounds Assembly Nut
14. [Jib Halyard Wire Block – 20052](#)
15. [Block, 22mm Single Micro – 20041](#)
16. Eyestraps
17. Eyestrapscrew (2)
18. [Spreader Bracket – 20171](#)
19. Spreader Bracket Screws
20. [Spreaders \(pair\) – 20127 \(Not Pictured\)](#)
21. [Spreader Tips – 20319 \(Not Pictured\)](#)
22. [Spinnaker Pole Ring – 20220](#)
23. Spinnaker Pole Ring Screw (2)
24. [Gooseneck Bracket – 20265](#)
25. Gooseneck Bracket Screw (6)
26. Gooseneck Pin
27. [Short Nose Clam Cleat – 20186](#)
28. Clam Cleat Screw
29. [Eyestraps – 20218](#)
30. Horn Cleat – 41004
31. Horn Cleat Screw (2)
32. [Vang Bail – 20213](#)
33. Vang Bail Screw (2)
34. [Cheek Block, 22mm \(2\) – 20219](#)
35. Cheek Block Screw
36. Standoff Spacer – 20221
37. [Cheek Block, 29mm \(Port\) – 20289](#)
38. Port Cheek Block Screw
39. [Mast Base Casting – 20129](#)
40. Mast Base Casting Rivet

Sails

1. [Mainsail - 20083](#)
2. [Jib sail - 20084](#)
3. [Tell Tales - 20272](#)
4. [Batten Set - 20274](#) (Not Pictured)
5. [Top Batten - 20089](#)
6. Middle Batten - 20263
7. Bottom Batten - 20264

Our spinnaker stock varies, please call or email for current or custom colors available.

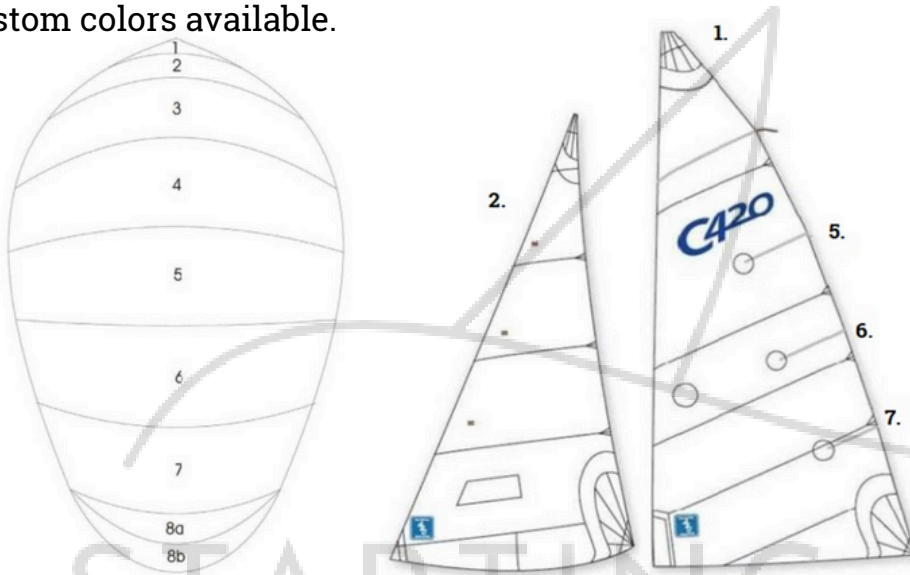

Spinnaker Poles

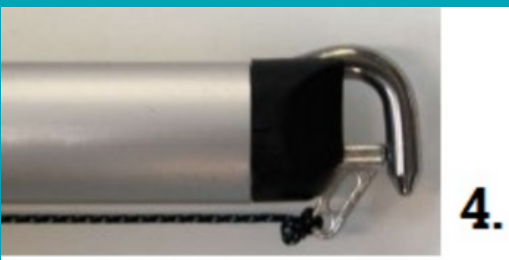

1. [Tapered Spinnaker Pole - 20085](#)
2. [Tapered Spin Pole End - 20183](#)
3. Non-Tapered Spin Pole - 20122
4. Non-Tapered Spin Pole End - 20088
5. Spin Pole Eyestraps (both) - 20118
6. Eyestraps Rivet (2)

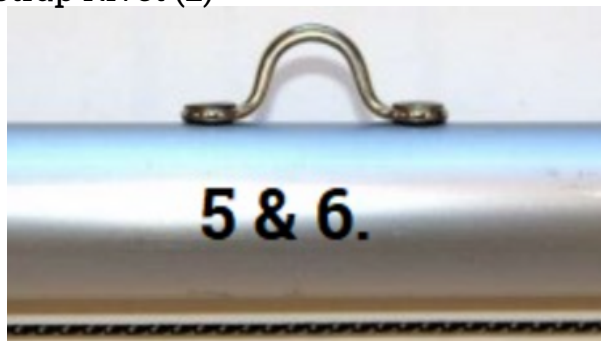

Rigging

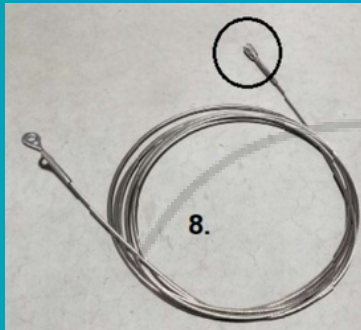

1. [Shroud Wire - 20057](#)
 2. [Shroud Adjuster - 20208](#)
 3. [Shroud Fast Pin - 20068](#) OR
 - 3b. [Shroud Clevis Pin - 23054](#)
 4. Roller Pin for Spin Guy - 20182
 5. Shroud Adjuster Cover - 20094
 6. Shroud Adjuster Cover, Long - 23081
 7. [Forestay Wire - 20058](#)
 8. Link Plate Style Shroud - 20111
 9. Shroud Link Plate - 23057
 10. Z-Force Vang, Complete - 20229
 11. Z-Force D Shackle - 20392
 12. [Z-Force Shock Block, Small - 24101](#)
 13. [Z-Force Stopper Ball - 24103](#)
 14. SCV 4:1 Vang, Complete - 20292
 15. SCV 4:1 Selden Vang - 20464
 16. [SCV 22mm Fiddle Block w/ Jam - 20149](#)
 17. [SCV 5mm Twist Shackle - 20267](#)
 18. [SCV 22mm Becket Block - 20070](#)
 19. SCV 5mm D Shackle - 20392
 20. [16:1 Vang, Complete - 20110](#)
 21. [16:1 Vang 22mm Micro Block \(4\) - 20041](#)
 22. [16:1 Vang 22mm Becket Block - 20070](#)
 23. [16:1 Vang 5mm Shackle \(2\) - 20071](#)
- Not pictured:
1. [Jib Halyard, Complete - 20061](#)
 2. [Jib Halyard Shackle - 20030](#)
 3. Main Halyard Ring - 20106
 4. [Main Halyard Stopper Ball - 20054](#)
 5. [Topping Lift Hook - 20060](#)
 6. Bridle - 20105 or [20280](#)
 7. [Bridle Block, 29mm Single - 20040](#)

Trapeze

1. [Trapeze, Complete - 20062](#)
2. Trapeze Ring w/ Block - 20066
3. [Trapeze Ring w/o Block – 20099](#)
4. Trapeze Clam Cleat - 20065
5. [Trapeze Donut Handle - 20064](#)
6. Trapeze Wire - 20390
7. [Trap Wire Shackle - 20020](#)

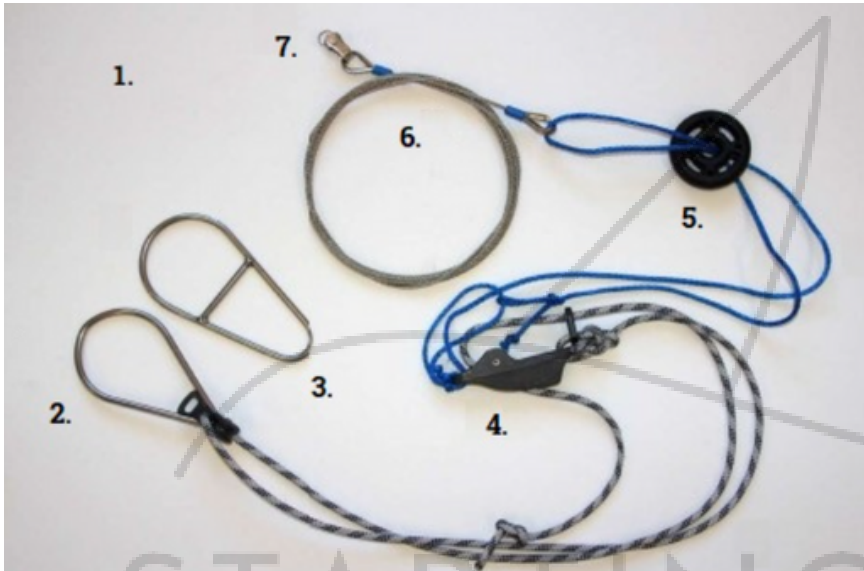

Accessories

1. [Dynamic Dolly – 20400/20401](#)
2. Blade Bag - 20209
3. [Hull Cover - 20093](#)
4. [Deck Cover - 20383](#)
5. [Mainsail Bag - 20279](#)
6. Spinnaker Storage Bag - 20211
7. C420 Line Kit - 20116