

HOBIE 18 / 18 SX

Decals -
 12451130 "Hobie" Red Each
 12451061 "Hobie" Diamond 36" Silver
 12452000 Silver pin stripe (ft)

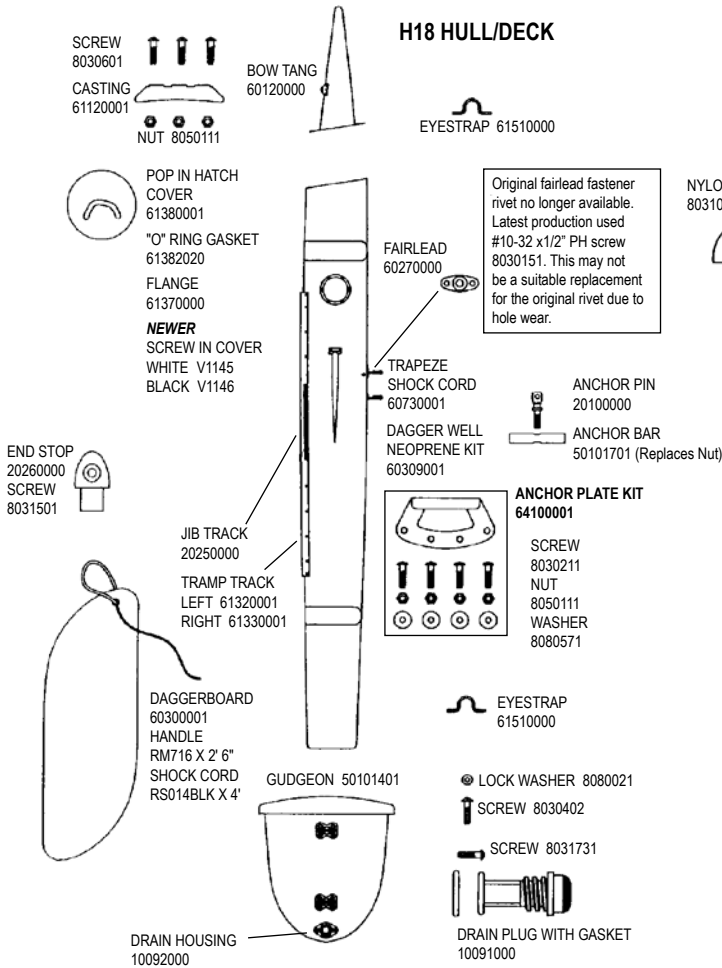

H18 TRAMPOLINE

COMPLETE TRAMPOLINE 6097XXXX
 (XXXX = Color / See parts list for available options)
 (Does not include lace line)

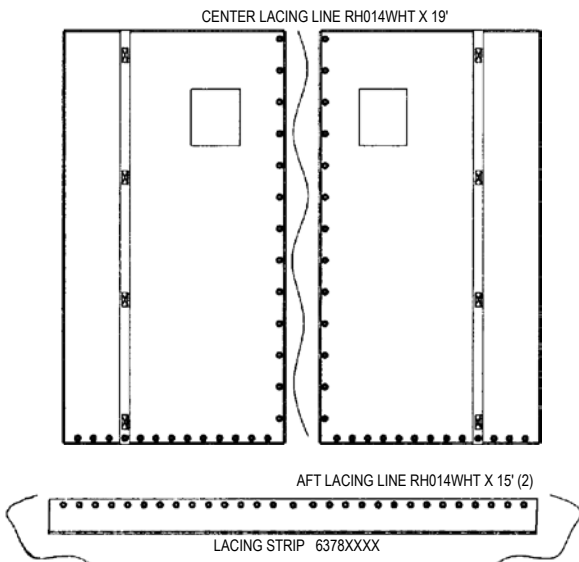

H18 FWD CROSSBAR

CROSSBAR WITH STEP CASTING
 BLACK 60132010

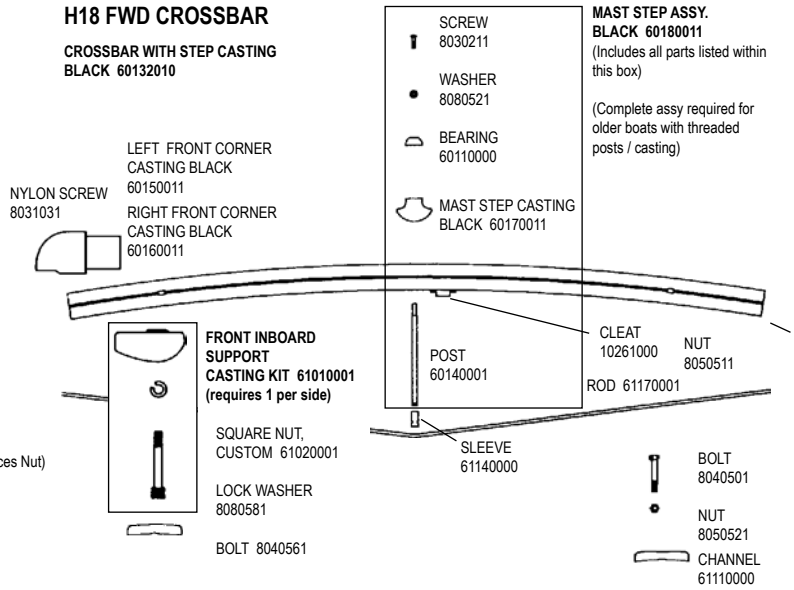

H18 REAR CROSSBAR

REAR CROSSBAR - EXTRUSION ONLY
 BLACK 60191211

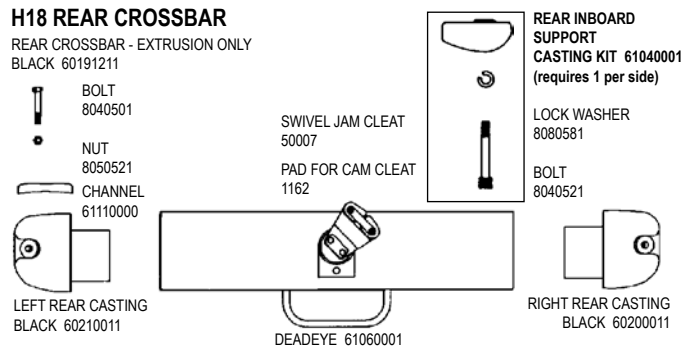

H18 MAIN TRAVELER CAR

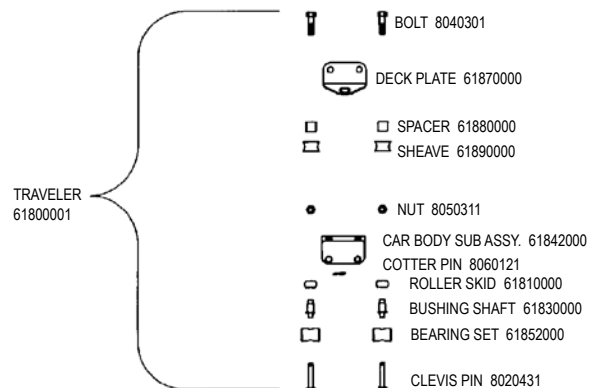

H18 / H18SXRUDDER ASSEMBLY

* = SUB ASSEMBLY PART // INCLUDED WITH CASTING

1986 AND EARLIER
60331010 CONVERSION KIT REQUIRED
INCLUDES: UPPER CASTING ASSEMBLIES, TUBE, END CAP, LOWER CASTING ASSEMBLIES, NUTS, BOLTS, GUDGEONS. FOR BOTH SIDES.

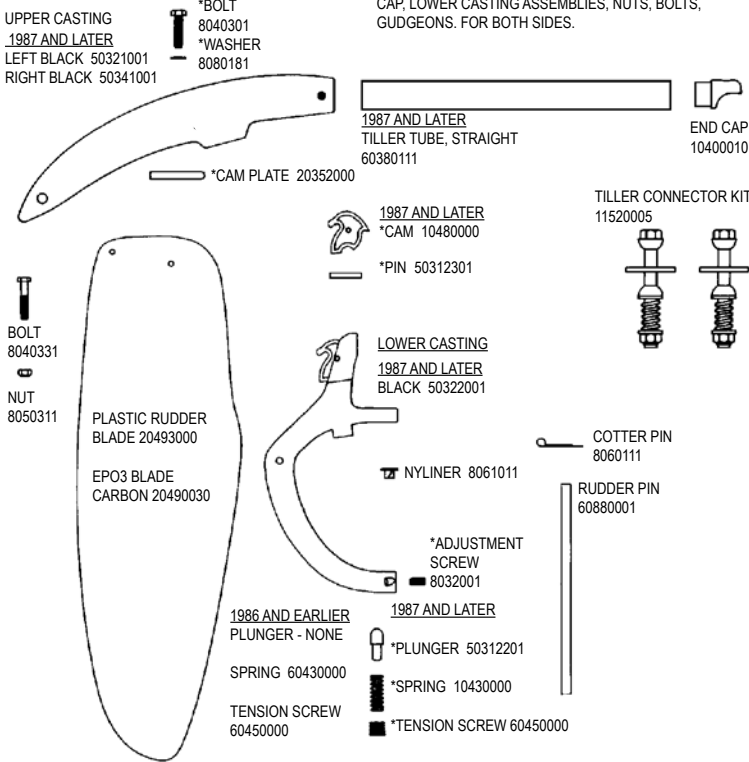

H18 / H18SX TILLER CROSSBAR & EXTENSION

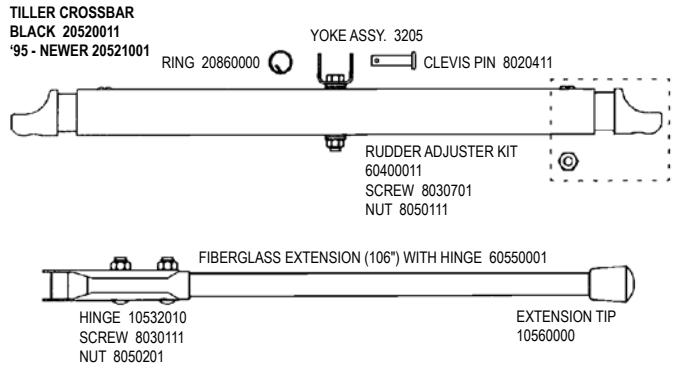

H18 / H18SX MAST

18 MAST ASSY. BLACK 60611001
18SX MAST ASSY. BLACK 68581000

COMPTIP ASSEMBLY 60611100

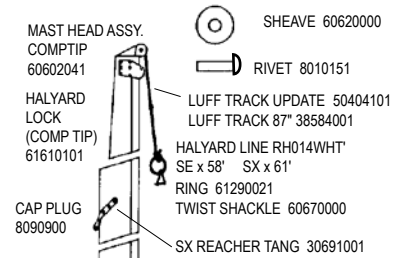

DANGER!
ALWAYS USE EXTREME CAUTION WHILE RAISING AND LOWERING YOUR MAST. CONTACT WITH A POWER LINE COULD BE FATAL.

H18 / H18SX DIAMOND WIRES

18 DIAMOND WIRE 61750001
18SX DIAMOND WIRE 68750001

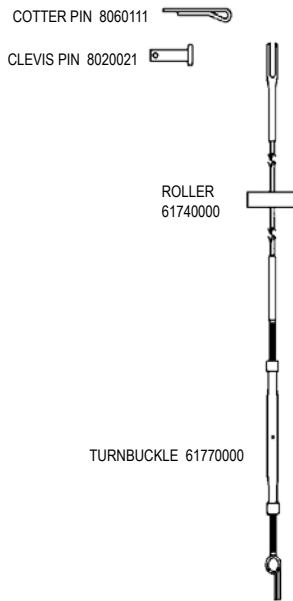

H18 / H18SX SPREADERS

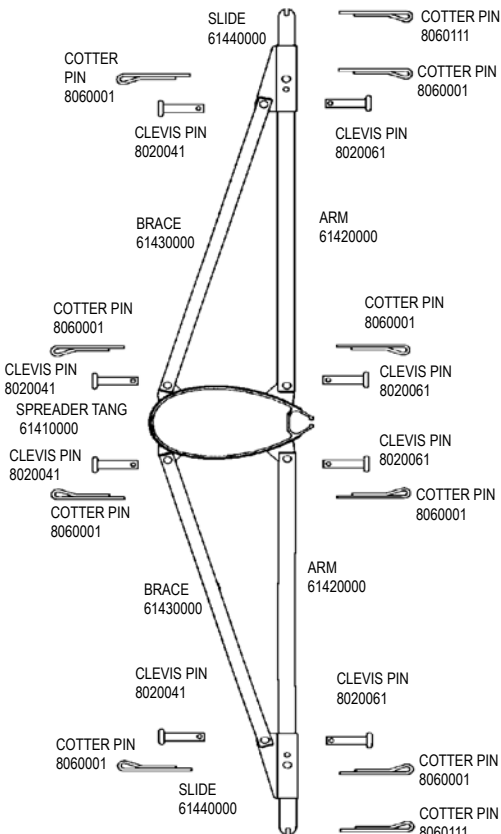

H18 / H18SX ROTATION ARM

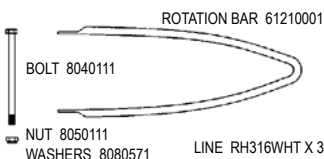

H18 / H18SX FORESTAY & JIB HALYARD

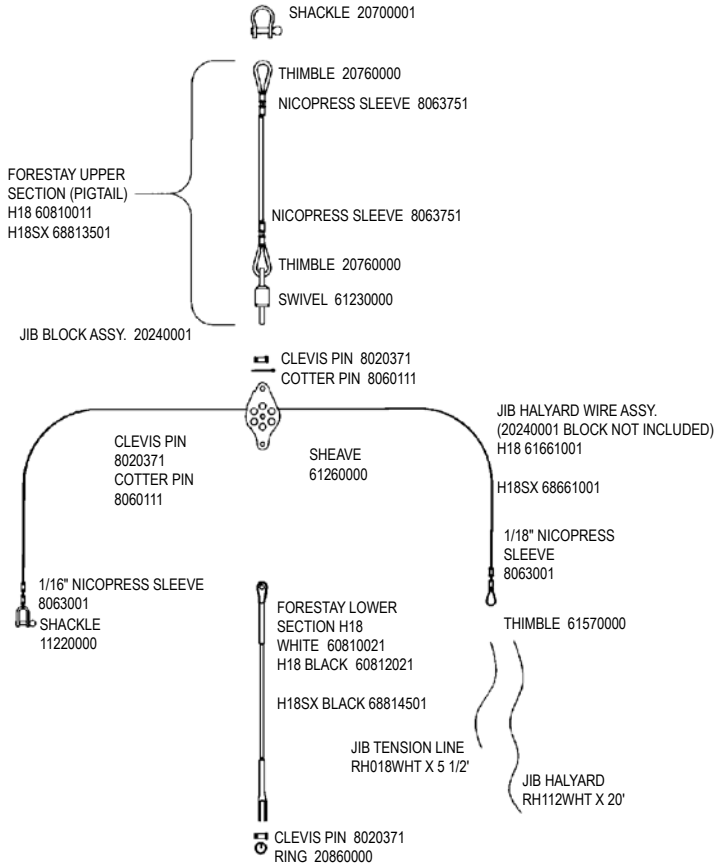

H18 / H18SX ROLLER FURLER

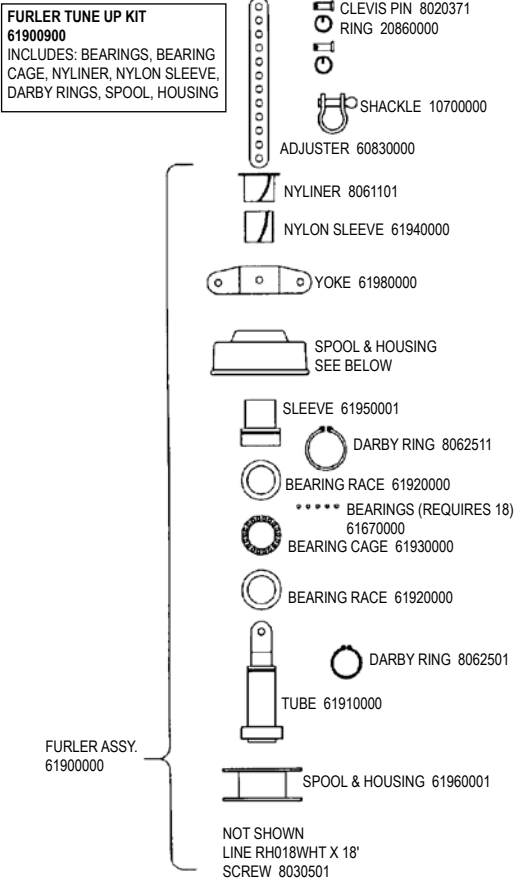

H18 / H18SX SHROUDS & ADJUSTERS

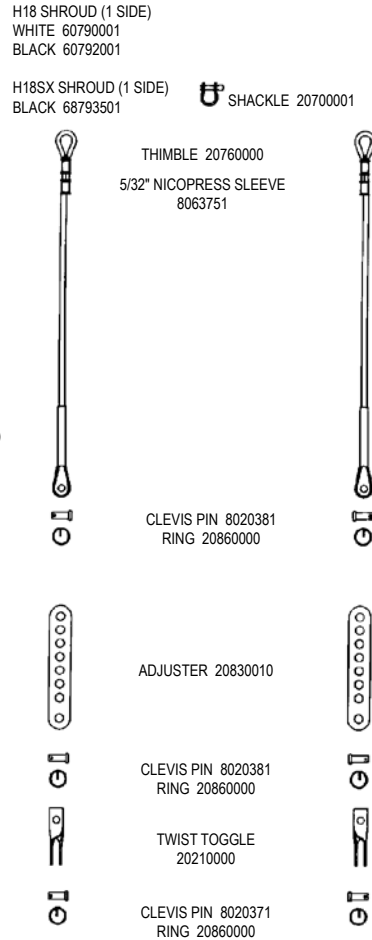

H18 RIVET GUIDE

() Indicates quantity needed to fasten part.

MAST	
HEAD	8010131 (2)
HALYARD HOOK	8011231 (6)
TANG	8010181 (12)
DIAMOND TANG	8010181 (3)
SPREADER TANG	8010181 (8)
COMPRESSION PLATE	8010181 (4)
GOOSENECK PLATE	8010181 (4)
GOOSENECK CLEAR	8010131 (2)
GOOSENECK BLOCK	8010131 (2)
BASE	8010131 (2)

(Note: all 8010181 mast rivets require 08011291 rivet caps)

REAR CROSSBAR	
CORNER CASTING	8011231 (6)
INBOARD SUPPORT	8010131 (2)
SWIVEL JAMMER	8010201 (1)
	8031501 (2)
	8031231 (1)
	8080011 (1)
	8050801 (1)
DEAD EYE	8010181 (4)

HULL	
TRAMPOLINE TRACK	8010121 (9)
(backup washers required on above, 8080551)	
ACCESS PORT FLANGE	8010141 (12)
EYE STRAP	8010131 (2)

BOOM	
END CAP	8010131 (2)

FRONT CROSSBAR	
MAST STEP	8010131 (4)
INBOARD SUPPORT	8010131 (2)
JAM CLEAT	8010181 (2)

RUDDER (UPPER CASTING)	
CASTING	8011231 (3)
END CAP	8010131 (2)

SAIL HARDWARE	
HEADBOARD	8010020 (16)
MAIN CLEW PLATE	8010020 (10)
BATTEN POCKET	8010020 (4)
JIB CLEW PLATE	8010020 (6)
(above rivets requires setting machine which is not available in a hand tool.)	

H18 / H18SX TRAPEZE WIRES



H18 / H18SX BRIDLES

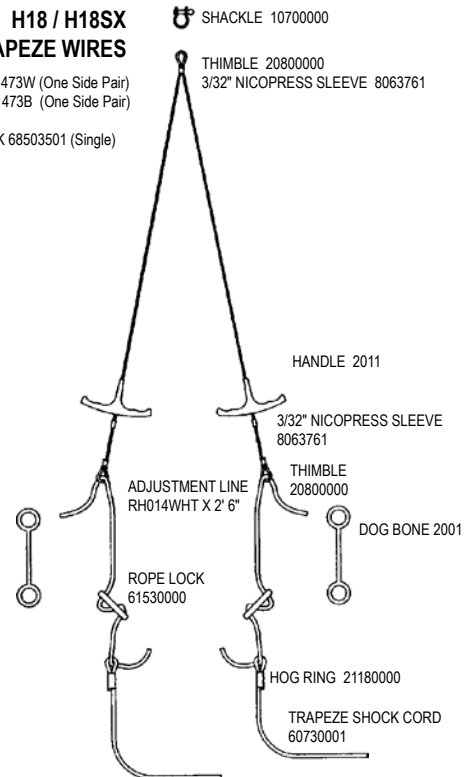
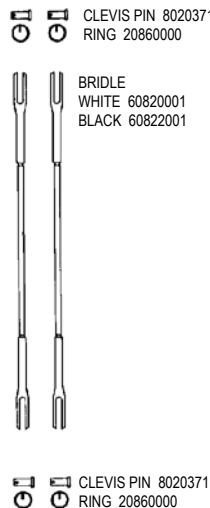

H18 MAIN SAIL & BATTENS

H18 60991XXX / H18SX 68991XXX
SEE NUMERICAL SECTION



HOBIE 18		HOBIE 18SX	
BATTEN #10	24 1/8"	BATTEN #9	28 1/2"
BATTEN #9	39 1/16"	BATTEN #8	46 1/8"
BATTEN #8	56 5/16"	BATTEN #7	67 7/8"
BATTEN #7	68 13/16"	BATTEN #6	83 5/16"
BATTEN #6	79 5/16"	BATTEN #5	93 7/8"
BATTEN #5	87 5/16"	BATTEN #4	100 9/16"
BATTEN #4	93 7/8"	BATTEN #3	103 3/4"
BATTEN #3	97 5/16"	BATTEN #2	104 11/16"
BATTEN #2	101 5/16"	BATTEN #1	102 11/16"
BATTEN #1	101 5/16"		

(FOR INDIVIDUAL BATTENS SEE UNIVERSAL BATTENS PAGE)

SAIL WIND INDICATOR
335

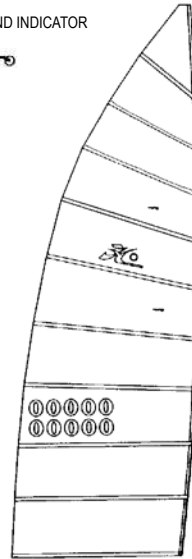

HEADBOARD WRIVETS
68330011

LOGO (PAIR)
WHITE 12430001
BLACK 12430011

CLASS INSIGNIA
62330000

BATTEN POCKET
END PROTECTOR
KIT 80550005

"HOBIE"
PROTECTOR
KIT 12480001

LEECH BATTEN TIP
11323000

LUFF TIP
11322011

BATTEN TIE LINE
RH112WHT X 18"

① 14" SAIL NUMBERS

	BLACK	WHITE
#1	12710030	12710000
#2	12720030	12720000
#3	12730030	12730000
#4	12740030	12740000
#5	12750030	12750000
#6&9	12760030	12760000
#7	12770030	12770000
#8	12780030	12780000
#0	12700030	12700000

MAIN CLEW PLATE-PAIR (WRIVETS) 62270000

SAIL BAG 21310000

JIB SAIL
H18 60992XXX
H18SX 68992XXX

ZIPPER
62300000

CLEW
PLATE
12240000

LUFF CLEAT KIT
62260001

SHACKLE 10870000

CLEW BLOCK 20680000

H18 / H18SX BOOM

BOOM ASSEMBLY BLACK
60720011

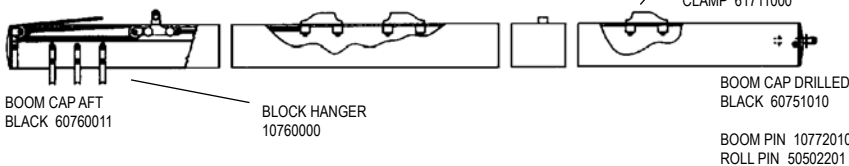

OUTHHAUL CAR ASSY 60220001 (OUTHHAUL AND SHOCK CORD NOT INCLUDED)

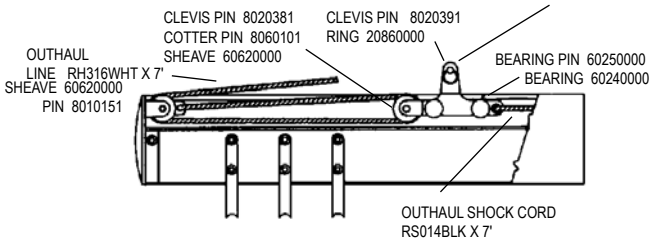

JIB SHEET BLOCK
HARKEN 60330041

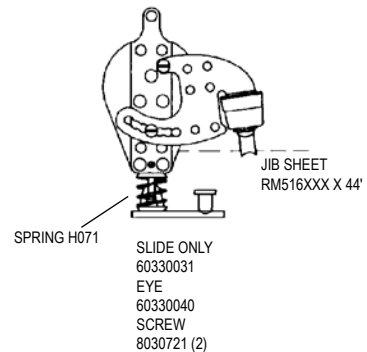

H18 BLOCK SET WITH LINE

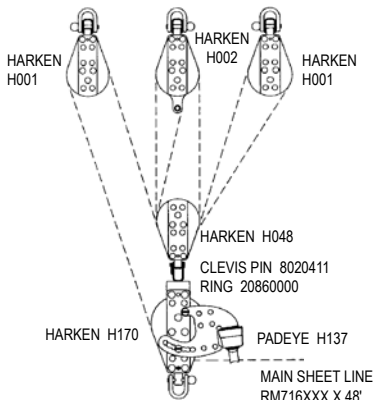

WING TRAMP SET BLACK 68040255
(does not include lace line)

